



2025

SPINE SYSTEM

PRODUCT CATALOG

MIS Spinal Pedicle Screw System (5.5mm System)



5.5 MIS Polyaxial Screw(Bone Cement)

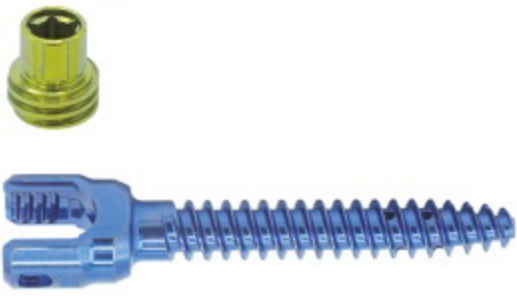

REF	Specification
2100-6302	Φ5.0×35mm
2100-6303	Φ5.0×40mm
2100-6308	Φ5.5×35mm
2100-6309	Φ5.5×40mm
2100-6310	Φ5.5×45mm
2100-6314	Φ6.0×35mm
2100-6315	Φ6.0×40mm
2100-6316	Φ6.0×45mm
2100-6317	Φ6.0×50mm

REF	Specification
2100-6321	Φ6.5×35mm
2100-6322	Φ6.5×40mm
2100-6323	Φ6.5×45mm
2100-6324	Φ6.5×50mm
2100-6325	Φ7.0×30mm
2100-6326	Φ7.0×35mm
2100-6327	Φ7.0×40mm
2100-6328	Φ7.0×45mm

5.5 MIS Monoaxial Screw(Bone Cement)



REF	Specification
2100-6402	Φ5.0×35mm
2100-6403	Φ5.0×40mm
2100-6408	Φ5.5×35mm
2100-6409	Φ5.5×40mm
2100-6410	Φ5.5×45mm
2100-6414	Φ6.0×35mm
2100-6415	Φ6.0×40mm
2100-6416	Φ6.0×45mm
2100-6417	Φ6.0×50mm

REF	Specification
2100-6420	Φ6.5×35mm
2100-6421	Φ6.5×40mm
2100-6422	Φ6.5×45mm
2100-6423	Φ6.5×50mm
2100-6424	Φ6.5×55mm
2100-6425	Φ7.0×30mm
2100-6426	Φ7.0×35mm
2100-6427	Φ7.0×40mm
2100-6428	Φ7.0×45mm

5.5 Straight Rod



REF	Specification
2100-4501	5.5*60mm
2100-4502	5.5*80mm
2100-4503	5.5*100mm
2100-4504	5.5*120mm
2100-4505	5.5*140mm

REF	Specification
2100-4506	5.5*160mm
2100-4507	5.5*180mm
2100-4508	5.5*200mm
2100-4509	5.5*240mm

5.5 Curved Rod



REF	Specification
2100-4601	5.5*60mm
2100-4602	5.5*70mm
2100-4603	5.5*80mm

REF	Specification
2100-4604	5.5*90mm
2100-4605	5.5*100mm
2100-4606	5.5*120mm

Bone Cement Injector (Sterilized)



REF	Specification
2200-2647	

Minimally Invasive Pedicle Screw System



5.5 Minimally Invasive Monoaxial Screw



REF	Specification
2100-4301	5.0*30
2100-4302	5.0*35
2100-4303	5.5*30
2100-4304	5.5*35
2100-4305	5.5*40
2100-4306	6.0*40
2100-4307	6.0*45
2100-4308	6.0*50

REF	Specification
2100-4314	6.5*35
2100-4309	6.5*40
2100-4310	6.5*45
2100-4311	6.5*50
2100-4312	7.0*35
2100-4313	7.0*40
2100-4315	7.0*45

5.5 Minimally Invasive Polyaxial Screw



REF	Specification
2100-4401	5.0*30
2100-4402	5.0*35
2100-4403	5.5*30
2100-4404	5.5*35
2100-4405	5.5*40
2100-4406	6.0*40
2100-4407	6.0*45
2100-4408	6.0*50

REF	Specification
2100-4414	6.5*35
2100-4409	6.5*40
2100-4410	6.5*45
2100-4411	6.5*50
2100-4412	7.0*35
2100-4413	7.0*40
2100-4415	7.0*45

5.5 Straight Rod



REF	Specification
2100-4501	5.5*60
2100-4502	5.5*80
2100-4503	5.5*100
2100-4504	5.5*120
2100-4505	5.5*140

REF	Specification
2100-4506	5.5*160
2100-4507	5.5*180
2100-4508	5.5*200
2100-4509	5.5*240

5.5 Curved Rod



REF	Specification
2100-4601	5.5*60
2100-4602	5.5*70
2100-4603	5.5*80
2100-4604	5.5*90
2100-4605	5.5*100
2100-4606	5.5*120

Spinal Pedicle Screw System (6.0mm System)

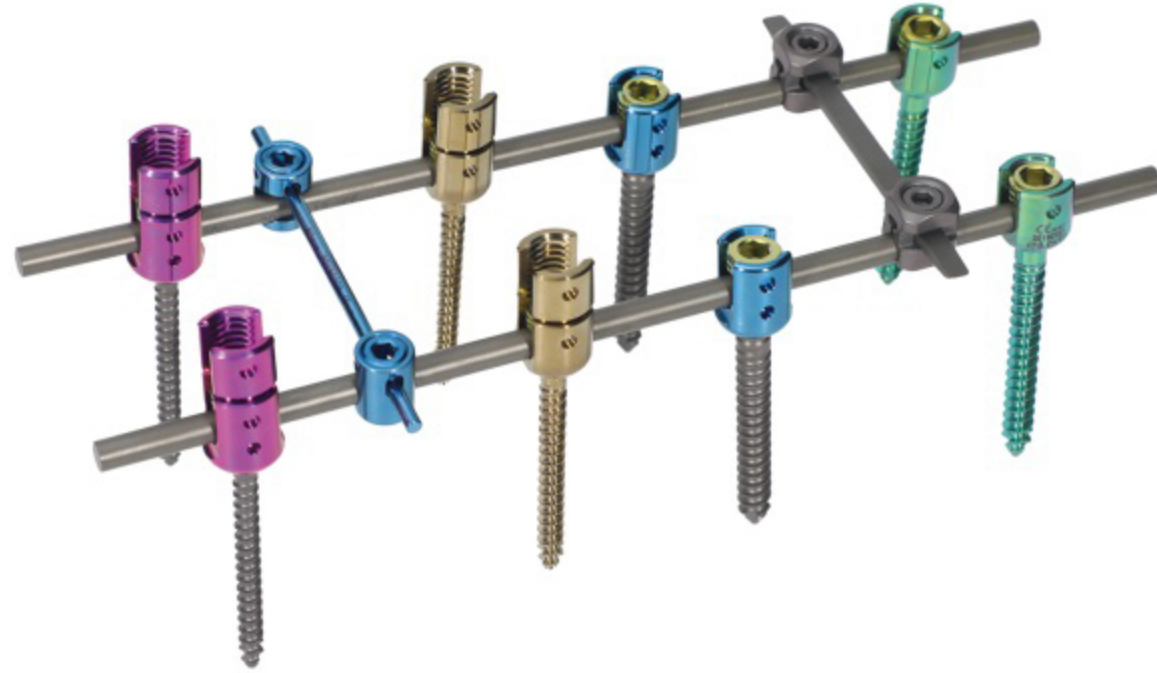

6.0 Monoaxial Pedical Screw



REF	Specification	REF	Specification
2100-0101	Φ4.5×25mm	2100-0116	Φ6.0×35mm
2100-0102	Φ4.5×30mm	2100-0117	Φ6.0×40mm
2100-0103	Φ4.5×35mm	2100-0118	Φ6.0×45mm
2100-0104	Φ4.5×40mm	2100-0119	Φ6.0×50mm
2100-0105	Φ4.5×45mm	2100-0130	Φ6.0×55mm
2100-0106	Φ5.0×30mm	2100-0120	Φ6.5×30mm
2100-0107	Φ5.0×35mm	2100-0121	Φ6.5×35mm
2100-0108	Φ5.0×40mm	2100-0122	Φ6.5×40mm
2100-0109	Φ5.0×45mm	2100-0123	Φ6.5×45mm
2100-0110	Φ5.5×30mm	2100-0124	Φ6.5×50mm
2100-0111	Φ5.5×35mm	2100-0131	Φ6.5×55mm
2100-0112	Φ5.5×40mm	2100-0125	Φ7.0×35mm
2100-0113	Φ5.5×45mm	2100-0126	Φ7.0×40mm
2100-0114	Φ5.5×50mm	2100-0127	Φ7.0×45mm
2100-0129	Φ5.5×55mm	2100-0128	Φ7.0×50mm
2100-0115	Φ6.0×30mm	2100-0132	Φ7.0×55mm

6.0 Monoaxial Reduction Screw



REF	Specification	REF	Specification
2100-0201	Φ5.0×30mm	2100-0211	Φ6.0×40mm
2100-0202	Φ5.0×35mm	2100-0212	Φ6.0×45mm
2100-0203	Φ5.0×40mm	2100-0213	Φ6.0×50mm
2100-0204	Φ5.0×45mm	2100-0214	Φ6.5×35mm
2100-0222	Φ5.0×50mm	2100-0215	Φ6.5×40mm
2100-0205	Φ5.5×30mm	2100-0216	Φ6.5×45mm
2100-0206	Φ5.5×35mm	2100-0217	Φ6.5×50mm
2100-0207	Φ5.5×40mm	2100-0218	Φ7.0×35mm
2100-0208	Φ5.5×45mm	2100-0219	Φ7.0×40mm
2100-0209	Φ5.5×50mm	2100-0220	Φ7.0×45mm
2100-0210	Φ6.0×35mm	2100-0221	Φ7.0×50mm

6.0 Polyaxial Pedical Screw



REF	Specification	REF	Specification	REF	Specification
2100-0301	Φ4.5×20mm	2100-0311	Φ5.5×30mm	2100-0322	Φ6.5×40mm
2100-0302	Φ4.5×25mm	2100-0312	Φ5.5×35mm	2100-0323	Φ6.5×45mm
2100-0303	Φ4.5×30mm	2100-0313	Φ5.5×40mm	2100-0324	Φ6.5×50mm
2100-0304	Φ4.5×35mm	2100-0314	Φ5.5×45mm	2100-0337	Φ6.5×55mm
2100-0305	Φ4.5×40mm	2100-0315	Φ5.5×50mm	2100-0325	Φ7.0×35mm
2100-0306	Φ4.5×45mm	2100-0334	Φ5.5×55mm	2100-0326	Φ7.0×40mm
2100-0329	Φ4.5×50mm	2100-0316	Φ6.0×35mm	2100-0327	Φ7.0×45mm
2100-0307	Φ5.0×30mm	2100-0317	Φ6.0×40mm	2100-0328	Φ7.0×50mm
2100-0308	Φ5.0×35mm	2100-0318	Φ6.0×45mm	2100-0341	Φ7.0×55mm
2100-0309	Φ5.0×40mm	2100-0319	Φ6.0×50mm	2100-0351	Φ7.5×35mm
2100-0310	Φ5.0×45mm	2100-0335	Φ6.0×55mm	2100-0352	Φ7.5×40mm
2100-0332	Φ5.0×50mm	2100-0320	Φ6.5×30mm	2100-0353	Φ7.5×45mm
2100-0333	Φ5.0×55mm	2100-0321	Φ6.5×35mm	2100-0354	Φ7.5×50mm

6.0 Polyaxial Reduction Screw



REF	Specification	REF	Specification	REF	Specification
2100-0421	Φ4.5×30mm	2100-0427	Φ5.0×50mm	2100-0412	Φ6.0×50mm
2100-0422	Φ4.5×35mm	2100-0404	Φ5.5×30mm	2100-0413	Φ6.5×35mm
2100-0423	Φ4.5×40mm	2100-0405	Φ5.5×35mm	2100-0414	Φ6.5×40mm
2100-0424	Φ4.5×45mm	2100-0406	Φ5.5×40mm	2100-0415	Φ6.5×45mm
2100-0425	Φ4.5×50mm	2100-0407	Φ5.5×45mm	2100-0416	Φ6.5×50mm
2100-0401	Φ5.0×30mm	2100-0408	Φ5.5×50mm	2100-0417	Φ7.0×35mm
2100-0402	Φ5.0×35mm	2100-0409	Φ6.0×35mm	2100-0418	Φ7.0×40mm
2100-0403	Φ5.0×40mm	2100-0410	Φ6.0×40mm	2100-0419	Φ7.0×45mm
2100-0426	Φ5.0×45mm	2100-0411	Φ6.0×45mm	2100-0420	Φ7.0×50mm

6.0 Iliac Pedicle Screw



REF	Specification
2100-5301	7.5*65mm
2100-5302	7.5*70mm
2100-5303	7.5*75mm
2100-5304	7.5*80mm
2100-5305	8.0*65mm
2100-5306	8.0*70mm
2100-5307	8.0*75mm
2100-5308	8.0*80mm

6.0 Crosslink-I



REF	Specification
2100-0501	60mm
2100-0502	70mm
2100-0503	80mm

6.0 Crosslink-II



REF	Specification
2100-2101	60mm
2100-2102	70mm
2100-2103	80mm

6.0 Rod

REF	Specification	REF	Specification
2100-0601	Φ6.0×100mm	2100-0605	Φ6.0×300mm
2100-0602	Φ6.0×150mm	2100-0606	Φ6.0×350mm
2100-0603	Φ6.0×200mm	2100-0607	Φ6.0×400mm
2100-0604	Φ6.0×250mm	2100-0608	Φ6.0×600mm

Gradient Titanium Rod

REF	Specification
2100-2201	3.5*100-6.0*200mm

6.0mm Pedicle Hook

REF	Specification
2100-2202	

6.0 Square Connector



REF	Specification
10100796	6.0-6.0(SW2.5)

6.0 Extend Connector

REF	Specification
10600019	6.0-6.0(SW2.5)

6.0 Iliac Pedicle Screw Shifter

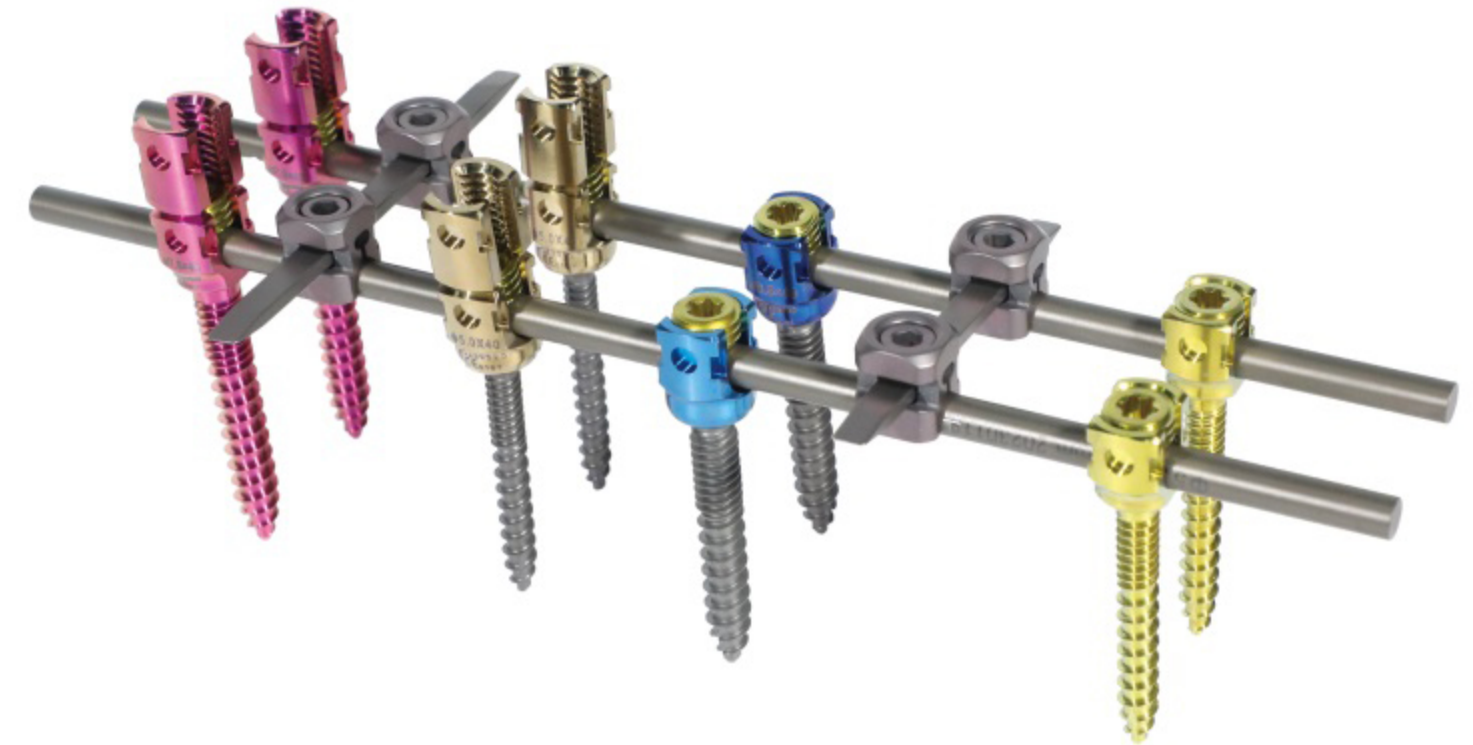
REF	Specification
2100-5401	6.0*30mm
2100-5402	6.0*40mm
2100-5403	6.0*50mm
2100-5404	6.0*60mm

Spinal Pedicle Screw System (5.5mm System)

5.5 Monoaxial Pedical Screw

REF	Specification	REF	Specification
2100-2301	Φ5.0*30mm	2100-2311	Φ6.0*45mm
2100-2302	Φ5.0*35mm	2100-2312	Φ6.0*50mm
2100-2303	Φ5.0*40mm	2100-2313	Φ6.5*35mm
2100-2304	Φ5.0*45mm	2100-2314	Φ6.5*40mm
2100-2305	Φ5.5*35mm	2100-2315	Φ6.5*45mm
2100-2306	Φ5.5*40mm	2100-2316	Φ6.5*50mm
2100-2307	Φ5.5*45mm	2100-2317	Φ7.0*35mm
2100-2308	Φ5.5*50mm	2100-2318	Φ7.0*40mm
2100-2309	Φ6.0*35mm	2100-2319	Φ7.0*45mm
2100-2310	Φ6.0*40mm	2100-2320	Φ7.0*50mm

5.5 Monoaxial Reduction Screw

REF	Specification	REF	Specification
2100-2401	Φ5.0*30mm	2100-2411	Φ6.0*45mm
2100-2402	Φ5.0*35mm	2100-2412	Φ6.0*50mm
2100-2403	Φ5.0*40mm	2100-2413	Φ6.5*35mm
2100-2404	Φ5.0*45mm	2100-2414	Φ6.5*40mm
2100-2405	Φ5.5*35mm	2100-2415	Φ6.5*45mm
2100-2406	Φ5.5*40mm	2100-2416	Φ6.5*50mm
2100-2407	Φ5.5*45mm	2100-2417	Φ7.0*35mm
2100-2408	Φ5.5*50mm	2100-2418	Φ7.0*40mm
2100-2409	Φ6.0*35mm	2100-2419	Φ7.0*45mm
2100-2410	Φ6.0*40mm	2100-2420	Φ7.0*50mm

5.5 Polyaxial Pedical Screw

REF	Specification	REF	Specification	REF	Specification
2100-2731	Φ4.5*30mm	2100-2706	Φ5.5*40mm	2100-2716	Φ6.5*50mm
2100-2732	Φ4.5*35mm	2100-2707	Φ5.5*45mm	2100-2725	Φ6.5*55mm
2100-2733	Φ4.5*40mm	2100-2708	Φ5.5*50mm	2100-2717	Φ7.0*35mm
2100-2734	Φ4.5*45mm	2100-2723	Φ5.5*55mm	2100-2718	Φ7.0*40mm
2100-2701	Φ5.0*30mm	2100-2709	Φ6.0*35mm	2100-2719	Φ7.0*45mm
2100-2702	Φ5.0*35mm	2100-2710	Φ6.0*40mm	2100-2720	Φ7.0*50mm
2100-2703	Φ5.0*40mm	2100-2711	Φ6.0*45mm	2100-2726	Φ7.5*35mm
2100-2704	Φ5.0*45mm	2100-2712	Φ6.0*50mm	2100-2727	Φ7.5*40mm
2100-2721	Φ5.0*50mm	2100-2724	Φ6.0*55mm	2100-2728	Φ7.5*45mm
2100-2722	Φ5.0*55mm	2100-2713	Φ6.5*35mm	2100-2729	Φ7.5*50mm
2100-2735	Φ5.5*30mm	2100-2714	Φ6.5*40mm	2100-2730	Φ7.5*55mm
2100-2705	Φ5.5*35mm	2100-2715	Φ6.5*45mm		

5.5 Polyaxial Reduction Screw

REF	Specification	REF	Specification
2100-2801	Φ5.0*30mm	2100-2811	Φ6.0*45mm
2100-2802	Φ5.0*35mm	2100-2812	Φ6.0*50mm
2100-2803	Φ5.0*40mm	2100-2813	Φ6.5*35mm
2100-2804	Φ5.0*45mm	2100-2814	Φ6.5*40mm
2100-2821	Φ5.5*30mm	2100-2815	Φ6.5*45mm
2100-2805	Φ5.5*35mm	2100-2816	Φ6.5*50mm
2100-2806	Φ5.5*40mm	2100-2817	Φ7.0*35mm
2100-2807	Φ5.5*45mm	2100-2818	Φ7.0*40mm
2100-2808	Φ5.5*50mm	2100-2819	Φ7.0*45mm
2100-2809	Φ6.0*35mm	2100-2820	Φ7.0*50mm
2100-2810	Φ6.0*40mm		

5.5 Iliac Pedicle Screw

REF	Specification
2100-5101	Φ7.5*65mm
2100-5102	Φ7.5*70mm
2100-5103	Φ7.5*75mm
2100-5104	Φ7.5*80mm
2100-5105	Φ8.0*65mm
2100-5106	Φ8.0*70mm
2100-5107	Φ8.0*75mm
2100-5108	Φ8.0*80mm

5.5 Crosslink

REF	Specification
2100-2901	60mm
2100-2902	70mm
2100-2903	80mm

5.5 Rod

REF	Specification
2100-3001	Φ5.5×100mm
2100-3002	Φ5.5×150mm
2100-3003	Φ5.5×200mm
2100-3004	Φ5.5×250mm
2100-3005	Φ5.5×300mm
2100-3006	Φ5.5×350mm
2100-3007	Φ5.5×400mm
2100-3008	Φ5.5×600mm

5.5 Iliac Pedicle Screw

REF	Specification
10400708	5.5-5.5(SW2.5)mm

5.5 Extend Connector

REF	Specification
0532055055	5.5-5.5(SW2.5)mm

5.5 Iliac Pedicle Screw Shifter

REF	Specification
2100-5201	5.5*30mm
2100-5202	5.5*40mm
2100-5203	5.5*50mm
2100-5204	5.5*60mm

Anterior Cervical Plate-I

REF	Specification
2100-0701	4 holes*25mm
2100-0702	4 holes*27mm
2100-0703	4 holes*30mm
2100-0704	4 holes*32mm
2100-0705	6 holes*35mm
2100-0706	6 holes*38mm
2100-0707	6 holes*41mm
2100-0708	6 holes*44mm
2100-0709	6 holes*47mm
2100-0710	8 holes*50mm
2100-0711	8 holes*53mm
2100-0712	8 holes*57mm
2100-0713	8 holes*60mm
2100-0714	8 holes*63mm
2100-0715	8 holes*66mm
2100-0716	8 holes*69mm
2100-0717	10 holes*72mm
2100-0718	10 holes*75mm
2100-0719	10 holes*78mm
2100-0720	10 holes*81mm

Anterior Cervical Screw-I



REF	Specification
2100-0801	Φ4*13mm
2100-0802	Φ4*14mm
2100-0803	Φ4*15mm
2100-0804	Φ4*16mm
2100-0809	Φ4*17mm
2100-0810	Φ4*18mm
2100-0805	Φ4.5*13mm
2100-0806	Φ4.5*14mm
2100-0807	Φ4.5*15mm
2100-0808	Φ4.5*16mm
2100-0811	Φ4.5*17mm
2100-0812	Φ4.5*18mm

Anterior Cervical Plate-II

REF	Specification
2100-0901	4 holes*22.5mm
2100-0902	4 holes*25mm
2100-0903	4 holes*27.5mm
2100-0904	4 holes*30mm
2100-0905	4 holes*32.5mm
2100-0906	4 holes*35mm
2100-0907	6 holes*37.5mm
2100-0908	6 holes*40mm
2100-0909	6 holes*43mm
2100-0910	6 holes*46mm
2100-0911	8 holes*51mm
2100-0912	8 holes*56mm
2100-0913	8 holes*61mm
2100-0914	8 holes*66mm
2100-0915	8 holes*71mm
2100-0916	8 holes*76mm
2100-0917	8 holes*81mm

Anterior Cervical Screw-II

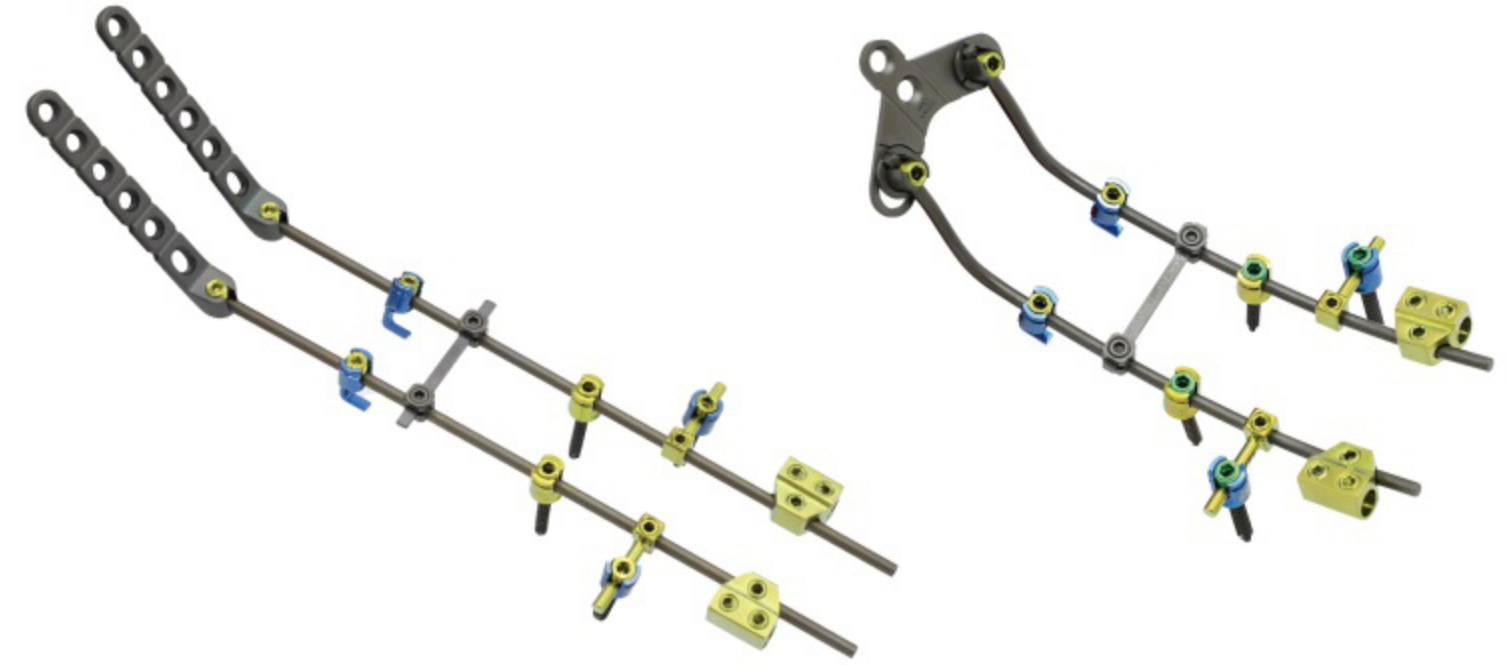
REF	Specification
2100-1001	Φ4*11mm
2100-1002	Φ4*13mm
2100-1003	Φ4*15mm
2100-1004	Φ4*17mm
2100-1005	Φ4*19mm
2100-1006	Φ4.5*11mm
2100-1007	Φ4.5*13mm
2100-1008	Φ4.5*15mm
2100-1009	Φ4.5*17mm
2100-1010	Φ4.5*19mm

Posterior Cervical Screw System

Polyaxial Pedical Screw

REF	Specification	REF	Specification
2100-1122	Φ3.5×10mm	2100-1123	Φ4.0×10mm
2100-1101	Φ3.5×12mm	2100-1111	Φ4.0×12mm
2100-1102	Φ3.5×14mm	2100-1112	Φ4.0×14mm
2100-1103	Φ3.5×16mm	2100-1113	Φ4.0×16mm
2100-1104	Φ3.5×18mm	2100-1114	Φ4.0×18mm
2100-1105	Φ3.5×20mm	2100-1115	Φ4.0×20mm
2100-1106	Φ3.5×22mm	2100-1116	Φ4.0×22mm
2100-1107	Φ3.5×24mm	2100-1117	Φ4.0×24mm
2100-1108	Φ3.5×26mm	2100-1118	Φ4.0×26mm
2100-1109	Φ3.5×28mm	2100-1119	Φ4.0×28mm
2100-1110	Φ3.5×30mm	2100-1120	Φ4.0×30mm

Occipital Plate-I

REF	Specification
2100-1201	32mm
2100-1202	37mm

3.5mm Rod

REF	Specification
2100-1201	32mm
2100-1202	37mm

3.5mm Prebend Rod

REF	Specification
2100-1303	3.5*160mm

Occipital Plate-II

REF	Specification
2100-1401	4 holes
2100-1402	5 holes
2100-1403	6 holes

Crosslink

REF	Specification
2100-1501	35mm
2100-1502	40mm
2100-1503	45mm

Laminar Hook

REF	Specification
2100-1601	/

Occipital Screws

REF	Specification
2100-1701	4.0*10mm
2100-1702	4.0*12mm
2100-1703	4.0*14mm
2100-1704	4.0*16mm
2100-1705	4.0*18mm

Domino Bolt

REF	Specification
2100-1602	3.5/6.0mm

Lateral Bolt

REF	Specification
2100-1603	/

Cervical Peek Cage-I

REF	Specification
2100-3801	4mm
2100-3802	5mm
2100-3803	6mm
2100-3804	7mm
2100-3805	8mm
2100-3806	9mm
2100-3807	10mm

Cervical Peek Cage-II

REF	Specification
2100-3901	4mm
2100-3902	5mm
2100-3903	6mm
2100-3904	7mm
2100-3905	8mm

Cervical Peek Cage(2 Locking Screws)

REF	Specification	REF	Specification
2100-4701	5mm	2100-4705	9mm
2100-4702	6mm	2100-4706	10mm
2100-4703	7mm	2100-4707	11mm
2100-4704	8mm	2100-4708	12mm

Cervical Peek Cage Screw (Self-drilling)

REF	Specification	REF	Specification
2100-4901	5mm	2100-4705	9mm
2100-4902	6mm	2100-4706	10mm
2100-4903	7mm	2100-4707	11mm
2100-4904	8mm	2100-4708	12mm
	Self-drilling		Self-tapping

Cervical Peek Cage (4 Locking Screws)

REF	Specification	REF	Specification
2100-4801	5mm	2100-4805	9mm
2100-4802	6mm	2100-4806	10mm
2100-4803	7mm	2100-4807	11mm
2100-4804	8mm	2100-4808	12mm

Cervical Peek Cage Locking Screw (Self-tapping)

REF	Specification
2100-5001	3.0*12mm
2100-5002	3.0*14mm
2100-5003	3.0*16mm
2100-5004	3.0*18mm

PLIF Peek Cage

REF	Specification	REF	Specification
2100-4001	8*22*10mm	2100-4007	12*26*10mm
2100-4002	10*22*10mm	2100-4008	14*26*10mm
2100-4003	12*22*10mm	2100-4009	8*32*10mm
2100-4004	14*22*10mm	2100-4010	10*32*10mm
2100-4005	8*26*10mm	2100-4011	12*32*10mm
2100-4006	10*26*10mm	2100-4012	14*32*10mm

TLIF Peek Cage



REF	Specification
2100-4105	7mm Height
2100-4101	9mm Height
2100-4102	11mm Height
2100-4103	13mm Height
2100-4104	15mm Height

T-PAL Peek Cage

REF	Specification	REF	Specification
2100-4201	7*10*28mm*0°	2100-4210	7*12*31mm*0°
2100-4202	8*10*28mm*5°	2100-4211	8*12*31mm*5°
2100-4203	9*10*28mm*5°	2100-4212	9*12*31mm*5°
2100-4204	10*10*28mm*5°	2100-4213	10*12*31mm*5°
2100-4205	11*10*28mm*5°	2100-4214	11*12*31mm*5°
2100-4206	12*10*28mm*5°	2100-4215	12*12*31mm*5°
2100-4207	13*10*28mm*5°	2100-4216	13*12*31mm*5°
2100-4208	15*10*28mm*5°	2100-4217	15*12*31mm*5°
2100-4209	17*10*28mm*5°	2100-4218	17*12*31mm*5°

OLIF Cage

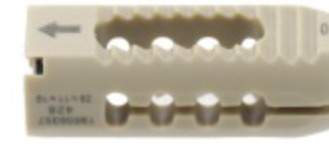
REF	Specification	REF	Specification
1122040008	40*18*8mm*0°	1123050008	50*18*8mm*6°
1122040010	40*18*10mm*0°	1123050010	50*18*10mm*6°
1122040012	40*18*12mm*0°	1123050012	50*18*12mm*6°
1122040014	40*18*14mm*0°	1123050014	50*18*14mm*6°
1122045008	45*18*8mm*0°	1123055008	55*18*8mm*6°
1122045010	45*18*10mm*0°	1123055010	55*18*10mm*6°
1122045012	45*18*12mm*0°	1123055012	55*18*12mm*6°
1122045014	45*18*14mm*0°	1123055014	55*18*14mm*6°
1122050008	50*18*8mm*0°	1124040009	40*18*9mm*9°
1122050010	50*18*10mm*0°	1124040011	40*18*11mm*9°
1122050012	50*18*12mm*0°	1124040013	40*18*13mm*9°
1122050014	50*18*14mm*0°	1124040015	40*18*15mm*9°
1122055008	55*18*8mm*0°	1124045009	45*18*9mm*9°
1122055010	55*18*10mm*0°	1124045011	45*18*11mm*9°
1122055012	55*18*12mm*0°	1124045013	45*18*13mm*9°
1122055014	55*18*14mm*0°	1124045015	45*18*15mm*9°
1123040008	40*18*8mm*6°	1124050009	50*18*9mm*9°
1123040010	40*18*10mm*6°	1124050011	50*18*11mm*9°
1123040012	40*18*12mm*6°	1124050013	50*18*13mm*9°
1123040014	40*18*14mm*6°	1124050015	50*18*15mm*9°
1123045008	45*18*8mm*6°	1124055009	55*18*9mm*9°
1123045010	45*18*10mm*6°	1124055011	55*18*11mm*9°
1123045012	45*18*12mm*6°	1124055013	55*18*13mm*9°
1123045014	45*18*14mm*6°	1124055015	55*18*15mm*9°

RAFUS PEEK Cage (Sterilized)

REF	Specification	REF	Specification
1023022008	22*9*8mm*0°	1026028008	28*9*8mm*0°
1023022009	22*9*9mm*0°	1026028009	28*9*9mm*0°
1023022010	22*11*10mm*0°	1027028010	28*11*10mm*0°
1024025008	25*9*8mm*0°	1027028011	28*11*11mm*0°
1024025009	25*9*9mm*0°	1028031010	31*11*10mm*0°
1025025010	25*11*10mm*0°	1028031011	31*11*11mm*0°
1025025011	25*11*11mm*0°		

Alif Peek Cage

REF	Specification	REF	Specification
12300034	42*20*16°mm	12300037	42*20*13*10°mm
12300035	42*20*11*10°mm	12300038	42*20*15*6°mm
12300036	42*20*13*6°mm	12300039	42*20*15*10°mm

Alif Peek Cage Locking Screw

REF	Specification
12100022	5.0*24mm
12100023	5.0*29mm
12100024	5.0*34mm

Titanium Lumbar Cage

REF	Specification	REF	Specification
2100-2501	8x10x20mm	2100-2506	10x10x26mm
2100-2502	8x10x22mm	2100-2507	12x10x20mm
2100-2503	8x10x26mm	2100-2508	12x10x22mm
2100-2504	10x10x20mm	2100-2509	12x10x26mm
2100-2505	10x10x22mm		

Interspinous Spacer (Titanium)

REF	Specification
2100-3701	6mm
2100-3702	8mm
2100-3703	10mm
2100-3704	12mm
2100-3705	14mm
2100-3706	16mm

Coflex Interlaminar Device (Titanium)

REF	Specification
2100-6106	6mm
2100-6108	8mm
2100-6110	10mm
2100-6112	12mm
2100-6114	14mm

Stryker Expandable Cage

REF	Specification	REF	Specification
12900001	18*19*3.0(19-24)	12900006	18*62*3.0(62-78)
12900002	18*23*3.0(23-30)	92100105	22*25*3.0(23-33.5)
12900003	18*29*3.0(29-42)	92100106	22*32*3.0(30-47.5)
12900004	18*32*3.0(32-48)	92100107	22*37*3.0(35-57.5)
12900005	18*47*3.0(47-63)		

End Cap

REF	Specification	REF	Specification
12900007	21*20*6.5*0°	92100102	22*0°
12900008	21*20*7*3°	92100103	22*3°
12900009	21*20*8.5*8°	92100104	22*8°

Extension

REF	Specification
92100101	18*15mm
92100108	22*15mm

Titanium Mesh Cage

REF	Specification
2100-2601	10x100mm
2100-2602	12x100mm
2100-2603	14x100mm
2100-2604	16x100mm
2100-2605	18x100mm
2100-2606	20x100mm

Expandable Titanium Cage

REF	Specification	REF	Specification
2100-3101	12*20mm	2100-3108	16*28mm
2100-3102	12*28mm	2100-3109	16*35mm
2100-3103	12*35mm	2100-3110	18*20mm
2100-3104	14*20mm	2100-3111	18*28mm
2100-3105	14*28mm	2100-3112	18*35mm
2100-3106	14*35mm	2100-3113	24*38mm
2100-3107	16*20mm		

Titanium Cervical Cage (Wedge-shaped)

REF	Specification	REF	Specification
100101000	4*15*12.5*7°	100106000	6.5*15*12.5*7°
100102000	4.5*15*12.5*7°	100107000	7*15*12.5*7°
100103000	5*15*12.5*7°	100108000	8.5*15*12.5*7°
100104000	5.5*15*12.5*7°	100109000	10*15*12.5*7°
100105000	6*15*12.5*7°		

Titanium Cervical Cage (Arc-shaped)

REF	Specification	REF	Specification
100201000	4*15*12.5*7°	100206000	6.5*15*12.5*7°
100202000	4.5*15*12.5*7°	100207000	7*15*12.5*7°
100203000	5*15*12.5*7°	100208000	8.5*15*12.5*7°
100204000	5.5*15*12.5*7°	100209000	10*15*12.5*7°
100205000	6*15*12.5*7°		

Expandable Posterior Lumbar Titanium Cage

REF	Specification
12700088	23*10*7(0°-12°)
12700083	23*10*9(0°-12°)
12700084	23*10*10(0°-12°)
12700085	23*11*11(0°-12°)
12700086	23*10*12(0°-12°)
12700087	23*10*13(0°-12°)

LIFUS Titanium Cage

REF	Specification	REF	Specification
1029022008	22*8*8*0°	1029028008	28*8*8 0°
1030022009	22*9*9*0°	1030028009	28*9*9 0°
1031022010	22*10*10*0°	1031028010	28*10*10 0°
1029025008	25*8*8*0°	1031028011	28*11*11 0°
1030025009	25*9*9*0°	1031028012	28*12*12 0°
1031025010	25*10*10*0°	1031031010	31*10*10 0°
1031025011	25*11*11*0°	1031031011	31*11*11 0°
1031025012	25*12*12*0°	1031031012	31*12*12 0°

3D Printing Plif Cage

REF	Specification	REF	Specification	REF	Specification
2100-5601	7*22*9*0°	2100-5612	10*22*11*0°	2100-5623	13*26*9*0°
2100-5602	8*22*9*0°	2100-5613	11*22*11*0°	2100-5624	14*26*9*0°
2100-5603	9*22*9*0°	2100-5614	12*22*11*0°	2100-5625	7*26*11*0°
2100-5604	10*22*9*0°	2100-5615	13*22*11*0°	2100-5626	8*26*11*0°
2100-5605	11*22*9*0°	2100-5616	14*22*11*0°	2100-5627	9*26*11*0°
2100-5606	12*22*9*0°	2100-5617	7*26*9*0°	2100-5628	10*26*11*0°
2100-5607	13*22*9*0°	2100-5618	8*26*9*0°	2100-5629	11*26*11*0°
2100-5608	14*22*9*0°	2100-5619	9*26*9*0°	2100-5630	12*26*11*0°
2100-5609	7*22*11*0°	2100-5620	10*26*9*0°	2100-5631	13*26*11*0°
2100-5610	8*22*11*0°	2100-5621	11*26*9*0°	2100-5632	14*26*11*0°
2100-5611	9*22*11*0°	2100-5622	12*26*9*0°		

3D Printing Cervical Cage

REF	Specification	REF	Specification	REF	Specification
2100-5501	4*11*14*0°	2100-5509	12*11*14*0°	2100-5517	9*11*14*7°
2100-5502	5*11*14*0°	2100-5510	13*11*14*0°	2100-5518	17*11*14*7°
2100-5503	6*11*14*0°	2100-5511	14*11*14*0°	2100-5519	11*11*14*7°
2100-5504	7*11*14*0°	2100-5512	4*11*14*7°	2100-5520	12*11*14*7°
2100-5505	8*11*14*0°	2100-5513	5*11*14*7°	2100-5521	13*11*14*7°
2100-5506	9*11*14*0°	2100-5514	6*11*14*7°	2100-5522	14*11*14*7°
2100-5507	10*11*14*0°	2100-5515	7*11*14*7°		
2100-5508	11*11*14*0°	2100-5516	8*11*14*7°		

3D Printing Alif Cage

REF	Specification	REF	Specification	REF	Specification
2100-5801	10*22*30*0°	2100-5810	18*24*32*0°	2100-5819	16*28*38*0°
2100-5802	12*22*30*0°	2100-5811	10*26*34*0°	2100-5820	18*28*38*0°
2100-5803	14*22*30*0°	2100-5812	12*26*34*0°	2100-5821	10*30*42*0°
2100-5804	16*22*30*0°	2100-5813	14*26*34*0°	2100-5822	12*30*42*0°
2100-5805	18*22*30*0°	2100-5814	16*26*34*0°	2100-5823	14*30*42*0°
2100-5806	10*24*32*0°	2100-5815	18*26*34*0°	2100-5824	16*30*42*0°
2100-5807	12*24*32*0°	2100-5816	10*28*38*0°	2100-5825	18*30*42*0°
2100-5808	14*24*32*0°	2100-5817	12*28*38*0°		
2100-5809	16*24*32*0°	2100-5818	14*28*38*0°		

3D Printing Tlif Cage

REF	Specification	REF	Specification	REF	Specification
2100-5701	7*40*14*0°	2100-5720	15*45*18*0°	2100-5739	13*45*22*0°
2100-5702	9*40*14*0°	2100-5721	7*50*18*0°	2100-5740	15*45*22*0°
2100-5703	11*40*14*0°	2100-5722	9*50*18*0°	2100-5741	7*50*22*0°
2100-5704	13*40*14*0°	2100-5723	11*50*18*0°	2100-5742	9*50*22*0°
2100-5705	15*40*14*0°	2100-5724	13*50*18*0°	2100-5743	11*50*22*0°
2100-5706	7*45*14*0°	2100-5725	15*50*18*0°	2100-5744	13*50*22*0°
2100-5707	9*45*14*0°	2100-5726	7*55*18*0°	2100-5745	15*50*22*0°
2100-5708	11*45*14*0°	2100-5727	9*55*18*0°	2100-5746	7*55*22*0°
2100-5709	13*45*14*0°	2100-5728	11*55*18*0°	2100-5747	9*55*22*0°
2100-5710	15*45*14*0°	2100-5729	13*55*18*0°	2100-5748	11*55*22*0°
2100-5711	7*40*18*0°	2100-5730	15*55*18*0°	2100-5749	13*55*22*0°
2100-5712	9*40*18*0°	2100-5731	7*60*18*0°	2100-5750	15*55*22*0°
2100-5713	11*40*18*0°	2100-5732	9*60*18*0°	2100-5751	7*60*22*0°
2100-5714	13*40*18*0°	2100-5733	11*60*18*0°	2100-5752	9*60*22*0°
2100-5715	15*40*18*0°	2100-5734	13*60*18*0°	2100-5753	11*60*22*0°
2100-5716	7*45*18*0°	2100-5735	15*60*18*0°	2100-5754	13*60*22*0°
2100-5717	9*45*18*0°	2100-5736	7*45*22*0°	2100-5755	15*60*22*0°
2100-5718	11*45*18*0°	2100-5737	9*45*22*0°		
2100-5719	13*45*18*0°	2100-5738	11*45*22*0°		

Posterior Cervical Laminoplasty System
Lateral Hole Plate

REF	Specification
SL2001-01	5 holes *8mm
SL2001-02	5 holes *10mm
SL2001-03	5 holes *12mm
SL2001-04	5 holes *14mm
SL2001-05	5 holes *16mm

Hinge Plate

REF	Specification
SL2002-02	4 holes *10mm
SL2002-03	4 holes *12mm
SL2002-04	4 holes *14mm

Graft Lateral Hole Plate

REF	Specification
SL2003-03	5 holes *10mm
SL2003-04	5 holes *12mm
SL2003-05	5 holes *14mm

Graft Plate

REF	Specification
SL2004-04	5 holes *10mm
SL2004-05	5 holes *12mm
SL2004-06	5 holes *14mm

Open Door Lateral Hole Plate

REF	Specification
SL2005-01	4 holes *5*10mm
SL2005-02	4 holes *5*12mm
SL2005-03	4 holes *5*14mm
SL2006-01	4 holes *7*10mm
SL2006-02	4 holes *7*12mm
SL2006-03	4 holes *7*14mm

Open Door Plate

REF	Specification
SL2007-01	4 holes *5*10mm
SL2007-02	4 holes *5*12mm
SL2007-03	4 holes *5*14mm
SL2008-01	4 holes *7*10mm
SL2008-02	4 holes *7*12mm
SL2008-03	4 holes *7*14mm

Laminoplasty Bone Screws

REF	Specification	REF	Specification
SL2009-01	2.0*5mm	SL2009-04	2.0*10mm
SL2009-02	2.0*6mm	SL2009-05	2.0*12mm
SL2009-03	2.0*8mm		

Laminoplasty Bone Screws

REF	Specification	REF	Specification
SL2010-01	2.5*5mm	SL2010-04	2.5*10mm
SL2010-02	2.5*6mm	SL2010-05	2.5*12mm
SL2010-03	2.5*8mm		

Anterior Thoracic Plate System

Anterior Thoracic Plate



REF	Specification	REF	Specification
2100-1801	60mm	2100-1808	95mm
2100-1802	65mm	2100-1809	100mm
2100-1803	70mm	2100-1810	105mm
2100-1804	75mm	2100-1811	110mm
2100-1805	80mm	2100-1812	120mm
2100-1806	85mm	2100-1813	130mm
2100-1807	90mm		

Thoracic Bolt



REF	Specification
2100-1901	5.5*30mm
2100-1902	5.5*35mm
2100-1903	5.5*40mm

Thoracic Screw



REF	Specification
2100-2001	5.0*30mm
2100-2002	5.0*35mm
2100-2003	5.0*40mm

Anterior Thoracolumbar Plate System

Anterior Thoracolumbar Plate



REF	Specification	REF	Specification
2100-3301	50mm	2100-3308	90mm
2100-3302	60mm	2100-3309	95mm
2100-3303	65mm	2100-3310	100mm
2100-3304	70mm	2100-3311	105mm
2100-3305	75mm	2100-3312	110mm
2100-3306	80mm	2100-3313	120mm
2100-3307	85mm	2100-3314	130mm

Thoracolumbar Bolt



REF	Specification
2100-3401	6.5*30mm
2100-3402	6.5*35mm
2100-3403	6.5*40mm
2100-3404	6.5*45mm
2100-3405	6.5*50mm

Thoracolumbar Screw



REF	Specification
2100-3501	6.5*30mm
2100-3502	6.5*35mm
2100-3503	6.5*40mm
2100-3504	6.5*45mm
2100-3505	6.5*50mm

5.5 MIS Posterior Thoracolumbar Instrument Set 2200-26

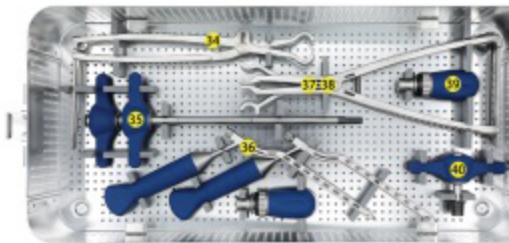
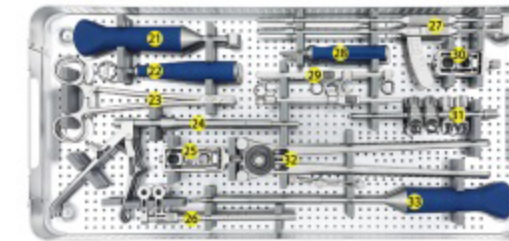
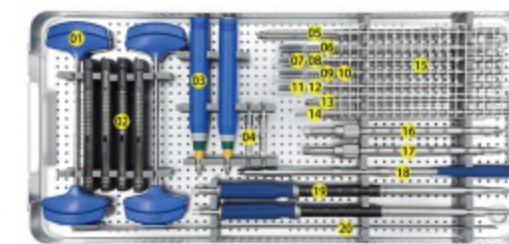

NO	REF	Description	Qty.
1	2200-2601	Puncture Needle 30-100mm	4
2	2200-2602	MIS Sleeve	8
3	2200-2603	Multi-stage Sleeve 5 Stages	2
4	2200-2604	Guide Wire Removal	2
5	2200-2605	Torx Screwdriver T27*280	1
6	2200-2606	Cannulated Tap Φ7.5	1
7	2200-2607	Cannulated Tap Φ7.0	1
8	2200-2608	Cannulated Tap Φ6.5	1
9	2200-2609	Cannulated Tap Φ6.0	1
10	2200-2610	Cannulated Tap Φ5.5	1
11	2200-2611	Cannulated Tap Φ5.0	1
12	2200-2612	Cannulated Tap Φ4.5	1
13	2200-2613	Adjustable Screwdriver	1
14	2200-2614	AWL	2
15	2200-2615	Location Plate	1
16	2200-2616	Removal Screwdriver	1
17	2200-2617	Drive Screwdriver	2
18	2200-2618	Nut holder T27*306	2
19	2200-2619	Compression Screwdriver T27*365	2
20	2200-2620	Guide Wire Φ1.5*480	8
21	2200-2621	Against Wrench	1
22	2200-2622	Parallel Connector Wrench	1
23	2200-2623	Rod Holding Forcep	1
24	2200-2624	MIS Sleeve Unlock Forcep	2
25	2200-2625	Cross Connector 3 Holes	1
26	2200-2626	Parallel Rod Measuring Device	1
27	2200-2627	Cross Rod Measuring Device	1
28	2200-2628	Rod Location Wrench	1
29	2200-2629	Arc Connector	2
30	2200-2630	Cross Connector 2 Holes	1
31	2200-2631	Parallel Connector	2
32	2200-2632	Rod Bender	1
33	2200-2633	Pre Lock Torx Screwdriver T27*368	1
34	2200-2634	Compression Forceo	1
35	2200-2635	Continuous Self-breaking Screwdriver	2
36	2200-2636	MIS Rod Placement Forcep	2
37	2200-2637	Distractor Forcep Long	1
38	2200-2638	Distractor Forcep	1
39	2200-2639	MIS Rechat Handle	2
40	2200-2640	T-shaped Handle	1
41	2200-2646-N	Aluminium Box	1

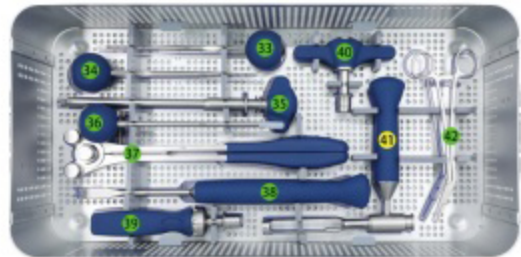
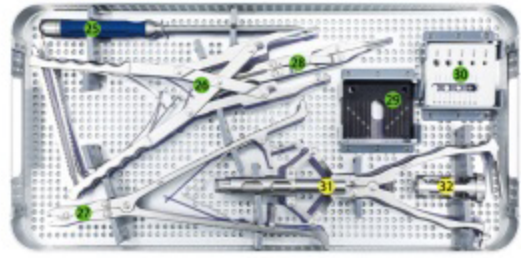
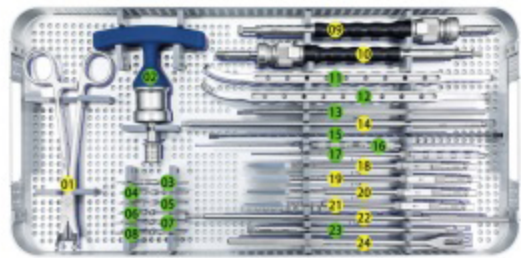
6.0mm Spinal Pedicle Screw Instrument Set 2200-28

NO	REF	Description	Qty.
1	2200-2801	6.0mm Rod Pushing Forcep	1
2	2200-1339	12.5N.m Torque Wrench	1
3	2200-2717	Fixation Pin Ball-type	2
4	2200-2717	Fixation Pin Ball-type	1
5	2200-2717	Fixation Pin Ball-type	1
6	2200-2718	Fixation Pin Pillar-type	2
7	2200-2718	Fixation Pin Pillar-type	1
8	2200-2718	Fixation Pin Pillar-type	1
9	2200-2803	6.0mm Screwdriver for Monoaxial Screw	1
10	2200-2802	6.0mm Screwdriver for Polyaxial Screw	1
11	2200-2712	In-situ Bending Iron L	1
12	2200-2713	In-situ Bending Iron R	1
13	2200-2716	Screwdriver SW3.5 Holder	1
14	2200-2804	6.0mm Crosslink Nut Holder SW5	1
15	2200-2707	Mould Rod 300mm	1
16	2200-2701	Double-Head Probe (Straight & Bent)	1
17	2200-2702	Single-head Probe(Straight)	1
18	2200-2805	6.0mm Tap ϕ 4.0 DLC Coating	1
19	2200-2806	6.0mm Tap ϕ 5.0 DLC Coating	1
20	2200-2807	6.0mm Tap ϕ 6.0 DLC Coating	1
21	2200-2808	6.0mm Tap ϕ 7.0 DLC Coating	1
22	2200-2809	6.0mm Screw Nut Holder SW5	1
23	2200-2708	Crosslink Screwdriver SW3.5	1
24	2200-2810	6.0mm Screw Cutter for Long Arm Screw	1
25	2200-2731	Insert Device for Fixation Pin	1
26	2200-2724	Parallel Compressor	1
27	2200-2723	Rod Twist	1
28	2200-2725	Parallel Spreader	1
29	2200-2719	Crosslink Measurement	1
30	2200-2720	Screw Measurement	1
31+32	2200-2845	6.0mm Spinal Persuader with sleeve	1
33	2200-2714	Pedicle Probe Straight	1
34	2200-2715	Pedicle Probe Bent	1
35	2200-2730	Rod Holde	1
36	2200-2734	AWL	1
37	2200-2733	Rod Bender	1
38	2200-2732	Rod Pusherial	1
39	2200-2735	Straight Rechat Screwdriver	1
40	2200-2736	T-handle Quick Coupling	1
41	2200-2813	6.0mm Counter Torque for Screw Cutter	1
42	2200-2721	Rod Holding Forcep	1
43	2200-2840-N	Aluminium Box	1

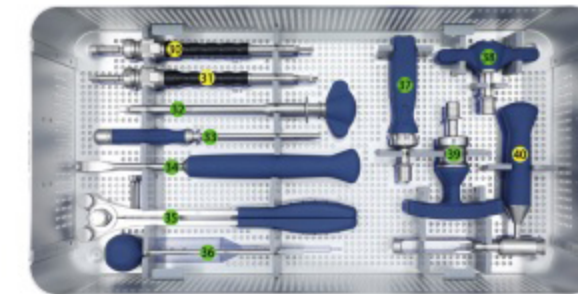
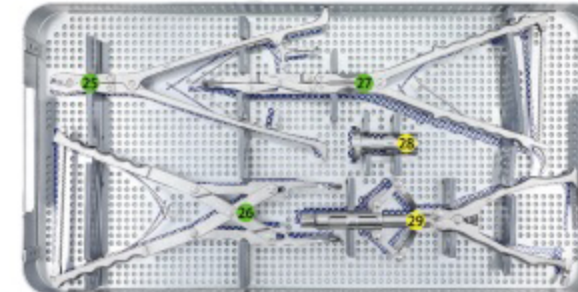
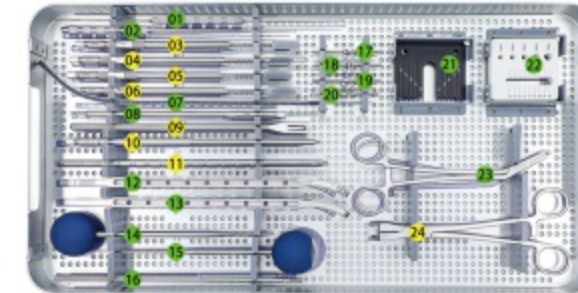
5.5mm Spinal Pedicle Screw Instrument Set 2200-27

NO	REF	Description	Qty.
1	2200-2701	Double-Head Probe (Straight & Bent)	1
2	2200-2702	Single-head Probe(Straight)	1
3	2200-2703	5.5mm Tap ϕ 4.5	1
4	2200-2704	5.5mm Tap ϕ 5.5	1
5	2200-2705	5.5mm Tap ϕ 6.5	1
6	2200-2706	5.5mm Tap ϕ 7.5	1
7	2200-2707	Mould Rod 300mm	1
8	2200-2708	Crosslink Screwdriver SW3.5	1
9	2200-2709	5.5mm Screw Cutter for Long Arm Screw	1
10	2200-2710	5.5mm Nut Screwdriver T27	1
11	2200-2711	5.5mm Screw Nut Holder T27	1
12	2200-2712	In-situ Bending Iron L	1
13	2200-2713	In-situ Bending Iron R	1
14	2200-2714	Pedicle Probe Straight	1
15	2200-2715	Pedicle Probe Bent	1
16	2200-2716	Screwdriver SW3.5 Holder	1
17	2200-2717	Fixation Pin Ball-type	2
18	2200-2717	Fixation Pin Ball-type	2
19	2200-2718	Fixation Pin Pillar-type	2
20	2200-2718	Fixation Pin Pillar-type	2
21	2200-2719	Crosslink Measurement	1
22	2200-2720	Screw Measurement	1
23	2200-2721	Rod Holding Forcep	1
24	2200-2722	5.5mm Rod Pushing Forcep	1
25	2200-2723	Rod Twist	1
26	2200-2724	Parallel Compressor	1
27	2200-2725	Parallel Spreader	1
28+29	2200-2743	5.5mm Spinal Persuader with Sleeve	1
30	2200-2729	5.5mm Screwdriver for Monoaxial Screw	1
31	2200-2728	5.5mm Screwdriver for Polyaxial Screw	1
32	2200-2730	Rod Holde	1
33	2200-2731	Insert Device for Fixation Pin	1
34	2200-2732	Rod Pusherial	1
35	2200-2733	Rod Bender	1
36	2200-2734	AWL	1
37	2200-2735	Straight Rechat Screwdriver	1
38	2200-2736	T-handle Quick Coupling	1
39	2200-2737	12.5N.m Torque Wrench	1
40	2200-2738	5.5mm Counter Torque for Screw Cutter	1
41	2200-2740-N	Aluminium Box	1

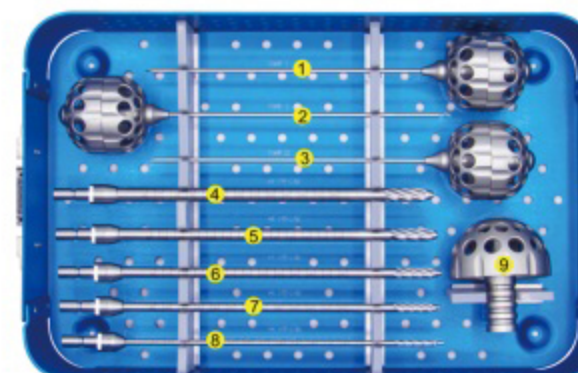
PTED Access Instrument Set (Percutaneous Transforaminal Endoscopic Discectomy) 2200-18

NO	REF	Description	Qty.
1	2200-1801	TOM Shidi (point tip)	1
2	2200-1802	TOM Shidi (blunt tip)	1
3	2200-1803	TOM Shidi	1
4	2200-1804	Manual Cannulated Bone Drill ϕ 4	1
5	2200-1805	Manual Cannulated Bone Drill ϕ 6	1
6	2200-1806	Manual Cannulated Bone Drill ϕ 7	1
7	2200-1807	Manual Cannulated Bone Drill ϕ 8	1
8	2200-1808	Manual Cannulated Bone Drill ϕ 9	1
9	2200-1809	Ball Handle	1
10	2200-1810-N	Aluminium Box	1

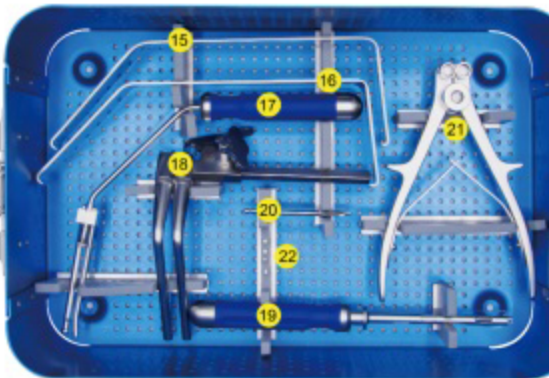
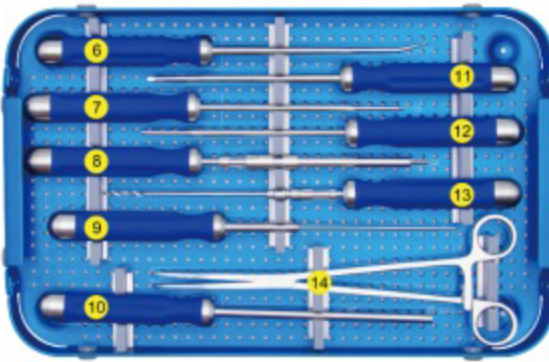
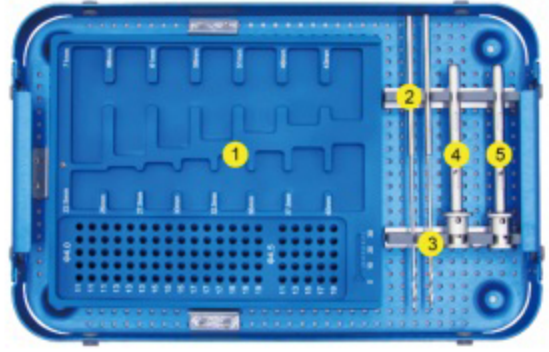
Anterior Cervical Plate Instrument Set 2200-02

NO	REF	Description	Qty.
1	2200-0201	Cervical Plate and Screw Box	1
2	2200-0202	Drill Bit Ø2.5	1
3	2200-0202	Drill Bit Ø2.5	1
4	2200-0204	Screw Holding Sleeve	1
5	2200-0204	Screw Holding Sleeve	1
6	2200-0206	Curette	1
7	2200-0207	Screwdriver Hex SW2.5	1
8	2200-0208	Tap with Stopper	1
9	2200-0209	AWL	1
10	2200-0210	Brace Screwdriver	1
11	2200-0211	Nut Screwdriver	1
12	2200-0212	Screwdriver Hex SW2.5	1
13	2200-0213	Hand Drill with Stopper	1
14	2200-0214	Plate Holder Forcep	1
15	2200-0215	Cervical Retractor	1
16	2200-0215	Cervical Retractor	1
17	2200-0217	Guider	1
18	2200-0218	Distractor	1
19	2200-0219	Location Screw Screwdriver	1
20	2200-0220	Brace Screw	2
21	2200-0221	Plate Bender	1
22	2200-0222	Location Screw	4
23	2200-0223-N	Aluminium Box	1

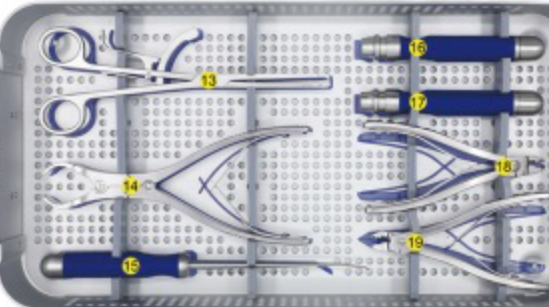
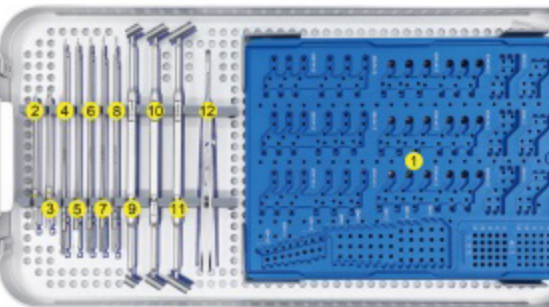
Laminar Shaping Plate Instrument Set 2200-09

NO	REF	Description	Qty.
1	2200-0901	Plate and Screw Box	1
2	2200-0902	Cross Screwdriver	1
3	2200-0902	Cross Screwdriver	1
4	2200-0904	AO Limited Bit 1.5*5mm	1
5	2200-0905	AO Limited Bit 1.5*6mm	1
6	2200-0906	AO Limited Bit 1.5*8mm	1
7	2200-0907	AO Limited Bit 1.5*10mm	1
8	2200-0908	AO Limited Bit 1.5*12mm	1
9	2200-0909	Mold Trial 8/10mm	1
10	2200-0910	Mold Trial 12/14mm	1
11	2200-0911	Mold Trial 16/18mm	1
12	2200-0912	Plate Holder	1
13	2200-0913	Plate Holding Forcep	1
14	2200-0914	Rongeur	1
15	2200-0915	Curette 3mm*10°	1
16	2200-0916	Straight Handle AO Quick Coupling	1
17	2200-0916	Straight Handle AO Quick Coupling	1
18	2200-0918	Plate Bender L	1
19	2200-0919	Plate Bender R	1
20	2200-0920-N	Aluminium Box	1

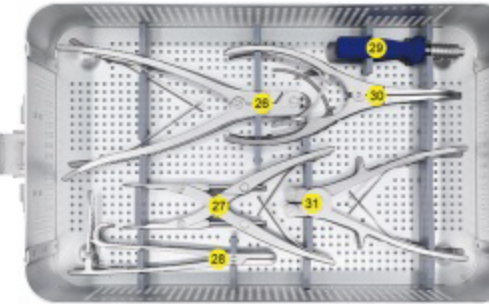
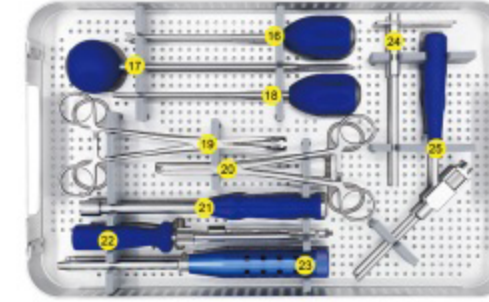
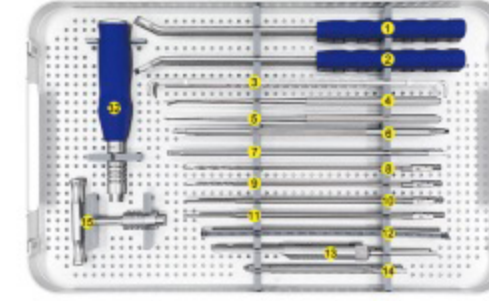
Posterior Cervical Screw Instrument Set 2200-03

NO	REF	Description	Qty.
1	2200-0301	In-situ Bending Iron Left	1
2	2200-0302	In-situ Bending Iron Right	1
3	2200-0303	Distractor	1
4	2200-0304	Feeler for Screw Channel Bent	1
5	2200-0305	Feeler for Screw Channel Straight	1
6	2200-0335	Hex Nut Holder SW2.5/3.0	1
7	2200-0334	Hex Screwdriver SW3.0 Long	1
8	2200-0308	Drill Bit Ø2.4	1
9	2200-0309	Drill Bit Ø2.7	1
10	2200-0310	Tap Ø3.5	1
11	2200-0311	Tap Ø4.0	1
12	2200-0312	Mould Rod Ø3.5	1
13	2200-0313	Depth Gauge 0-40mm	1
14	2200-0314	Hex Screwdriver SW2.5 Short	1
15	2200-0315	Quick Coupling T-handle	1
16	2200-0316	Rod Pusher	1
17	2200-0317	Hole Open Forcep	1
18	2200-0318	AWL	1
19	2200-0319	Screw/Hook Holder Forcep	1
20	2200-0320	Rod Holder Forcep	1
21	2200-0321	Counter Torque	1
22	2200-0322	Pedicle Screw Screwdriver	1
23	2200-0323	Insert Device for Fixation Pin	1
24	2200-0324	Protection Sleeve	1
25	2200-0325	Drill Guider	1
26	2200-0326	Rod Cutter	1
27	2200-0327	Parallel Compression Forcep	1
28	2200-0328	Rod Twist	1
29	2200-0329	Quick Coupling Straight Handle	1
30	2200-0330	Distractor Forcep	1
31	2200-0331	Rod Bender	1
32	2200-0340	3.0N.m Torque Handle	1
33	2200-0332-N	Aluminium Box	1

Posterior Cervical Screw Persuader 2200-0333

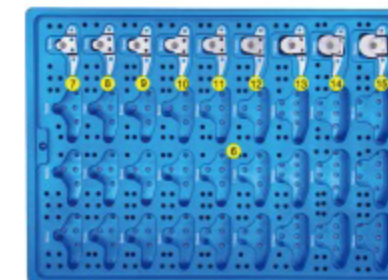
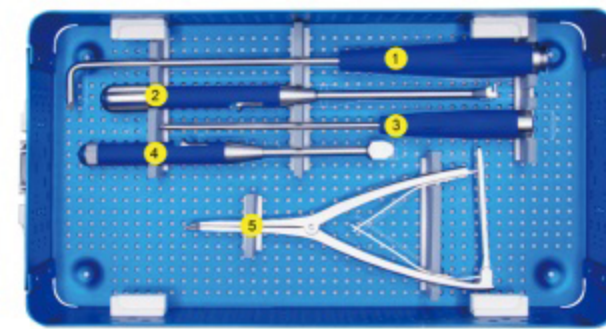
Interspinous Spacer Instrument Set 2200-11

NO	REF	Description	Qty.
1	2200-1101	AWL	1
2	2200-1102	Spacer Holder	1
3	2200-1103	Screwdriver SW3.0	1
4	2200-1104	Trial Spacer Holder	1
5	2200-1105	Spreader	1
6	2200-1106	Spacer Case	1
7	2200-1107	Trial Spacer 6mm	1
8	2200-1108	Trial Spacer 7mm	1
9	2200-1109	Trial Spacer 8mm	1
10	2200-1110	Trial Spacer 9mm	1
11	2200-1111	Trial Spacer 10mm	1
12	2200-1112	Trial Spacer 11mm	1
13	2200-1113	Trial Spacer 12mm	1
14	2200-1114	Trial Spacer 14mm	1
15	2200-1115	Trial Spacer 16mm	1
16	2200-1116-N	Aluminium Box	1

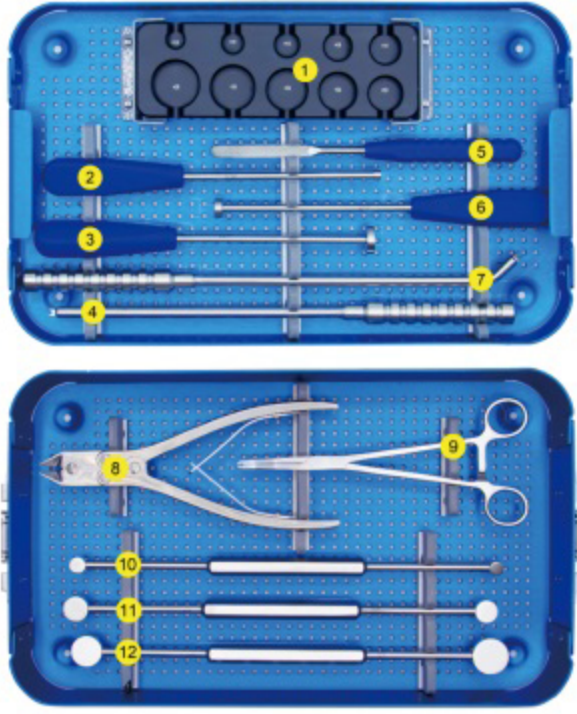
Titanium Mesh Cage Instrument Set 2200-05

NO	REF	Description	Qty.
1	2200-0501	Cage Stand	1
2	2200-0502	Pressure 6mm	1
3	2200-0503	Pressure 18mm	1
4	2200-0504	Pusher Straight	1
5	2200-0505	Osteotribe	1
6	2200-0506	Pressure 12mm	1
7	2200-0507	Pusher Curved	1
8	2200-0508	Cage Cutter	1
9	2200-0509	Cage Holding Forcecp	1
10	2200-0512	Implant Measure 10/12mm	1
11	2200-0521	Implant Measure 16/18mm	1
12	2200-0522	Implant Measure 22/25mm	1
13	2200-0513-N	Aluminium Box	1

Posterior Cervical Screw Instrument Set 2200-07

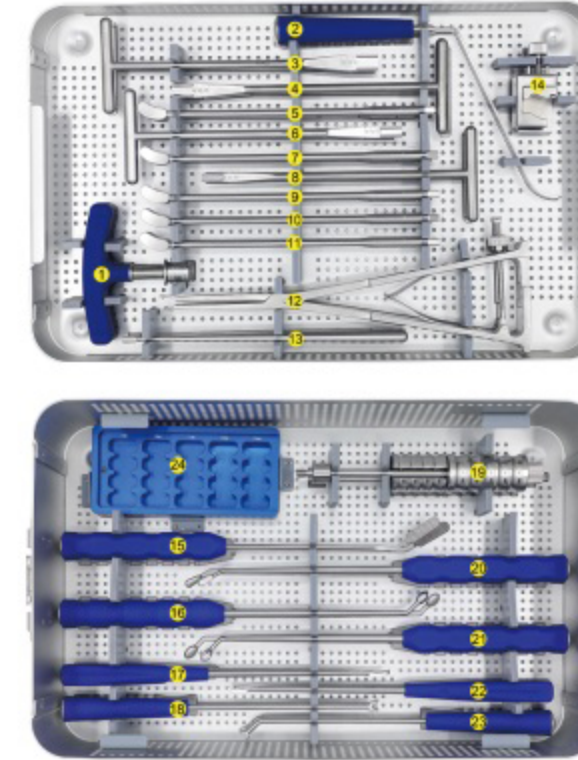

NO	REF	Description	Qty.
1	2200-0701	Trail 20*8mm	1
2	2200-0702	Trail 20*12mm	1
3	2200-0703	Trail 22*8mm	1
4	2200-0704	Trail 12*22mm	1
5	2200-0705	Trail 26*8mm	1
6	2200-0706	Trail 26*12mm	1
7	2200-0707	Trail 20*10mm	1
8	2200-0708	Trail 20*14mm	1
9	2200-0709	Trail 22*10mm	1
10	2200-0710	Trail 22*14mm	1
11	2200-0711	Trail 26*10mm	1
12	2200-0712	Reamer 7mm	1
13	2200-0713	Reamer 8mm	1
14	2200-0714	Reamer 9mm	1
15	2200-0715	Bone Graft Inserter	1
16	2200-0716	Hammer	1
17	2200-0717	Trail 26*14mm	1
18	2200-0718	Trail 32*8mm	1
19	2200-0719	Trail 32*10mm	1
20	2200-0720	Trail 32*12mm	1
21	2200-0721	Trail 32*14mm	1
22	2200-0722	Distractor 6*24mm	1
23	2200-0723	Bone Graft Cage	1
24	2200-0724	Cage Holder	1
25	2200-0725	Curette	1
26	2200-0726	Nerve Dissector	1
27	2200-0727	Reamer 8*6.5mm	1
28	2200-0728	Reamer 8.5*7.5mm	1
29	2200-0729	Reamer 9.5*8.5mm	1
30	2200-0730	Reamer 10*10.5mm	1
31	2200-0731	Reamer 10.5*11.5mm	1
32	2200-0732	Implant Cage Box	1
33	2200-0733-N	Aluminium Box	1

TLIF PEEK Cage Instrument Set 2200-08

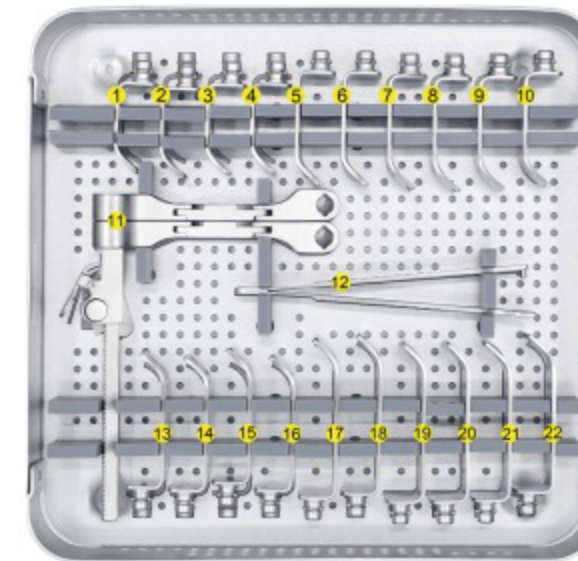
NO	REF	Description	Qty.
1	2200-0801	T-handle Quick Coupling	1
2	2200-0802	Insert Guider	1
3	2200-0803	Flat Reamer 13mm	1
4	2200-0804	Flat Reamer 11mm	1
5	2200-0805	Trial 7*25mm	1
6	2200-0806	Flat Reamer 9mm	1
7	2200-0807	Trial 9*25mm	1
8	2200-0808	Flat Reamer 7mm	1
9	2200-0809	Trial 11*25mm	1
10	2200-0810	Trial 13*25mm	1
11	2200-0811	Trial 15*25mm	1
12	2200-0812	Cage Holding Forcecp	1
13	2200-0813	Bone Graft Inserter	1
14	2200-0814	Bone Graft Cage	1
15	2200-0815	Curved Implanter	1
16	2200-0816	Curette 8mm Right	1
17	2200-0817	Side Curette 8mm	1
18	2200-0818	Straight Implanter	1
19	2200-0819	Sliding Hammer	1
20	2200-0820	Ring Curette 7mm	1
21	2200-0821	Curette 8mm Left	1
22	2200-0822	Side Curette 6mm	1
23	2200-0823	Curved Implanter	1
24	2200-0824	Implant Cage Box	1
25	2200-0825-N	Aluminium Box	1

Cervical Distractor Instrument Set 2200-10

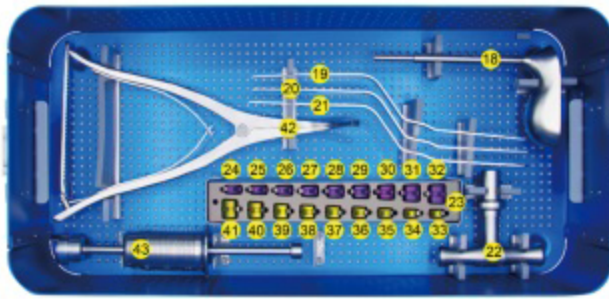
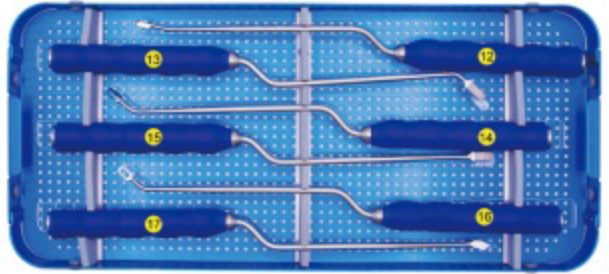
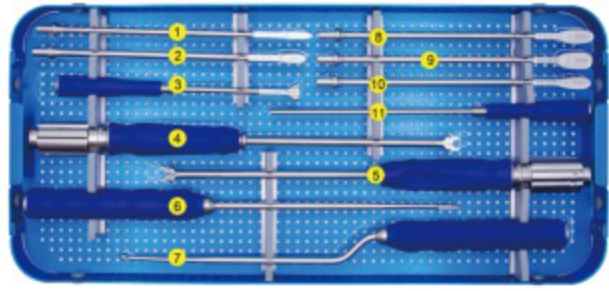
NO	REF	Description	Qty.
1	2200-1001	Retractor Blade Curved 20*30	1
2	2200-1002	Retractor Blade Curved 20*30	1
3	2200-1003	4 Toothed Retractor Blade 20*30	1
4	2200-1004	4 Toothed Retractor Blade 20*30	1
5	2200-1005	Retractor Blade Curved 24*40	1
6	2200-1006	Retractor Blade Curved 24*40	1
7	2200-1007	5 Toothed Retractor Blade 24*40	1
8	2200-1008	5 Toothed Retractor Blade 24*40	1
9	2200-1009	Retractor Blade Blunt 24*40	1
10	2200-1010	Retractor Blade Blunt 24*40	1
11	2200-1011	Retractor	1
12	2200-1012	Holding Forcecp	1
13	2200-1013	Retractor Blade Curved 20*50	1
14	2200-1014	Retractor Blade Curved 20*50	1
15	2200-1015	4 Toothed Retractor Blade 24*40	1
16	2200-1016	4 Toothed Retractor Blade 24*40	1
17	2200-1017	Retractor Blade Curved 25*60	1
18	2200-1018	Retractor Blade Curved 25*60	1
19	2200-1019	5 Toothed Retractor Blade 25*60	1
20	2200-1020	5 Toothed Retractor Blade 25*60	1
21	2200-1021	Retractor Blade Blunt 25*60	1
22	2200-1022	Retractor Blade Blunt 25*60	1
23	2200-1023-N	Aluminium Box	1

T-PAL Peek Cage Instrument Set 2200-12

NO	REF	Description	Qty.
1	2200-1201	Reamer 7mm	1
2	2200-1202	Reamer 9mm	1
3	2200-1203	Compactor	1
4	2200-1204	T-PAL Trail Applicator	1
5	2200-1204	T-PAL Trail Applicator	1
6	2200-1205	Straight Osteotome	1
7	2200-1207	Ring Type Bone Curette	1
8	2200-1208	Reamer 13mm	1
9	2200-1209	Reamer 15mm	1
10	2200-1210	Reamer 11mm	1
11	2200-1211	Bone Graft Insertor	1
12	2200-1212	Square Type Bone Curette	1
13	2200-1213	Curved Bone File	1
14	2200-1214	Square Type Bone Curette L	1
15	2200-1215	Straight Bone File	1
16	2200-1216	Square Type Bone Curette R	1
17	2200-1217	Curved Stuffer	1
18	2200-1218	Bone Graft Funnel	1
19	2200-1219	Soft Tissue Retractor 6mm	1
20	2200-1220	Soft Tissue Retractor 8mm	1
21	2200-1221	Soft Tissue Retractor 10mm	1
22	2200-1222	Quick-coupling T-handle	1
23	2200-1223	Trail Spacer Box	1
24	2200-1224	Trail T-PAL Spacer 7mm L	1
25	2200-1225	Trail T-PAL Spacer 8mm L	1
26	2200-1226	Trail T-PAL Spacer 9mm L	1
27	2200-1227	Trail T-PAL Spacer 10mm L	1
28	2200-1228	Trail T-PAL Spacer 11mm L	1
29	2200-1229	Trail T-PAL Spacer 12mm L	1
30	2200-1230	Trail T-PAL Spacer 13mm L	1
31	2200-1231	Trail T-PAL Spacer 15mm L	1
32	2200-1232	Trail T-PAL Spacer 17mm L	1
33	2200-1233	Trail T-PAL Spacer 7mm S	1
34	2200-1234	Trail T-PAL Spacer 8mm S	1
35	2200-1235	Trail T-PAL Spacer 9mm S	1
36	2200-1236	Trail T-PAL Spacer 10mm S	1
37	2200-1237	Trail T-PAL Spacer 11mm S	1
38	2200-1238	Trail T-PAL Spacer 12mm S	1
39	2200-1239	Trail T-PAL Spacer 13mm S	1
40	2200-1240	Trail T-PAL Spacer 15mm S	1
41	2200-1241	Trail T-PAL Spacer 17mm S	1
42	2200-1242	Spreader Forcep	1
43	2200-1243	Slidng Hammer	1
44	2200-1244	Aluminium Box	1

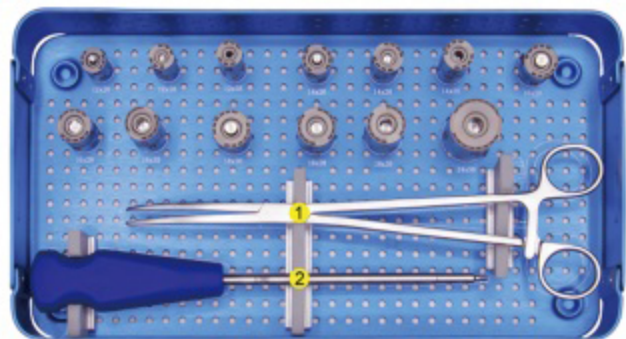
Expandable Titanium Cage Instrument Set 2200-15

NO	REF	Description	Qty.
1	2200-0214	Cage Holding Forcep	1
2	4200-1502	Hex Screwdriver SW2.5 Without Sleeve	1
3	2200-1503-N	Aluminium Box	1

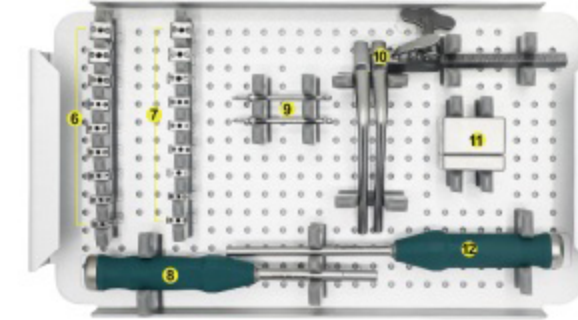
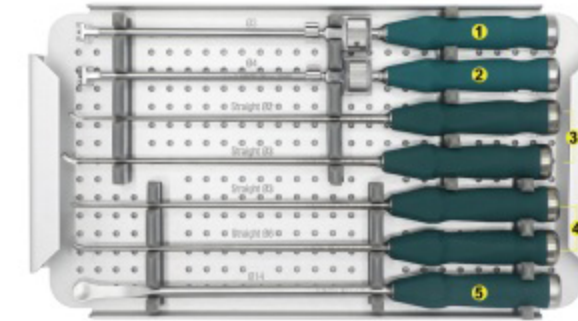
Titanium Cervical Cage Instrument Set 2200-23

NO	Description	Qty	
1	2200-2301	Cage Trail & Insertor Small	1
2	2200-2302	Cage Trail & Insertor Large	1
3	2200-2303	Ring Curette (Straight, 2mm)	1
	2200-2330	Ring Curette (Straight, 3mm)	1
4	2200-2304	Bent Curette (Straight, 3mm)	1
	2200-2331	Bent Curette (Straight, 6mm)	1
5	2200-2305	Periosteal Elevator	1
6	2200-2306	Cage Trail Wedge Shape 4.0mm	1
	2200-2307	Cage Trail Wedge Shape 4.5mm	1
	2200-2308	Cage Trail Wedge Shape 5.0mm	1
	2200-2309	Cage Trail Wedge Shape 5.5mm	1
	2200-2310	Cage Trail Wedge Shape 6.0mm	1
	2200-2311	Cage Trail Wedge Shape 6.5mm	1
	2200-2312	Cage Trail Wedge Shape 7.0mm	1
	2200-2313	Cage Trail Wedge Shape 8.5mm	1
	2200-2314	Cage Trail Wedge Shape 10.0mm	1
7	2200-2315	Cage Trail Arc Shape 4.0mm	1
	2200-2316	Cage Trail Arc Shape 4.5mm	1
	2200-2317	Cage Trail Arc Shape 5.0mm	1
	2200-2318	Cage Trail Arc Shape 5.5mm	1
	2200-2319	Cage Trail Arc Shape 6.0mm	1
	2200-2320	Cage Trail Arc Shape 6.5mm	1
	2200-2321	Cage Trail Arc Shape 7.0mm	1
	2200-2322	Cage Trail Arc Shape 8.5mm	1
	2200-2323	Cage Trail Arc Shape 10.0mm	1
8	2200-2324	Brace Screwdriver	1
9	2200-2325	Brace Screw	2
10	2200-2326	Distractor	1
11	2200-2327	Bone Graft Box	1
12	2200-2328	Bone Impactor	1
13	2200-2329	Aluminium Box	1

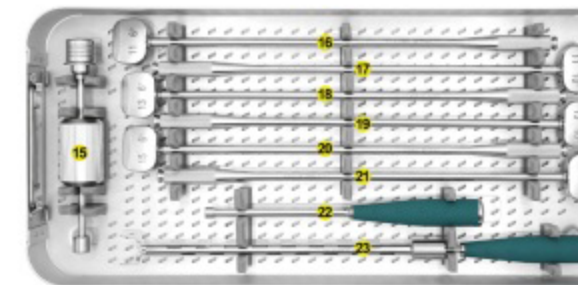
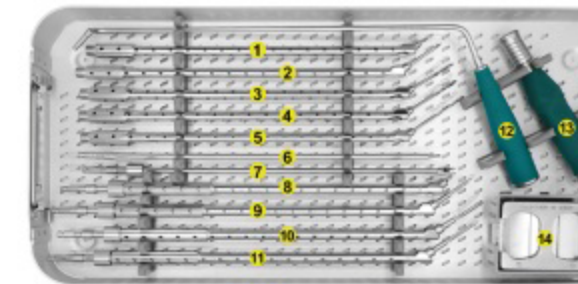
ALIF PEEK Cage Instrument Set 123

NO	REF	Description	Qty
1	1230047	Rotation Screwdriver	1
2	1230053	AWL	1
3	1230050	Drill bit 3.0*25	1
4	1230051	Drill bit 3.0*30	1
5	1230052	Drill bit 3.0*35	1
6	1230055	Screwdriver SW2.5	1
7	1230064	Screw Holder	1
8	1230054	Screwdriver Universal	1
9	1230046	Tap 5.0*25	1
10	1230048	Tap 5.0*30	1
11	1230049	Tap 5.0*35	1
12	1230045	Drill Guider	1
13	102205	Straight handle	1
14	1230063	Graft Box	1
15	315082	Hammer	1
16	1230056	Trail 11mm 6°	1
17	1230057	Trail 11mm 10°	1
18	1230058	Trail 13mm 6°	1
19	1230059	Trail 13mm 10°	1
20	1230060	Trail 15mm 6°	1
21	1230061	Trail 15mm 10°	1
22	1230062	Pusher	1
23	1230044	Cage Holder	1
24	1230065	Aluminium Box	1

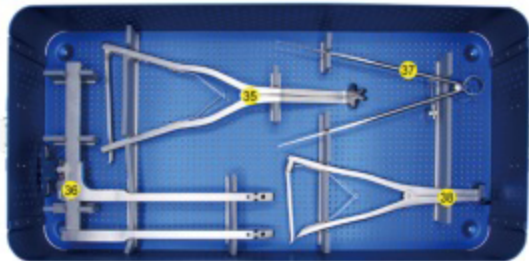
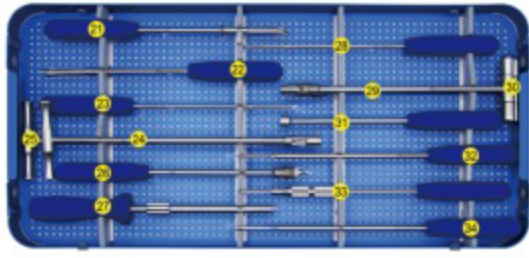
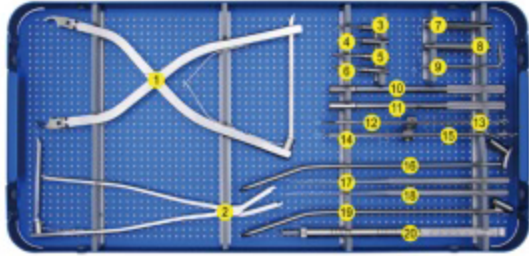
Anterior Thoracic & Thoracolumbar Plate Instrument Set 2200-25

NO	REF	Description	Qty
1	2200-2501	Compression Forcep	1
2	2200-2502	Curved Plate Holding Forcep	1
3	2200-2503	Brace Screw P=2.5	1
4	2200-2503	Brace Screw P=2.5	1
5	2200-2505	Brace Screw P=2.75	1
6	2200-2505	Brace Screw P=2.75	1
7	2200-2507	Compression Forcep Sleeve	1
8	2200-2507	Compression Forcep Sleeve	1
9	2200-2509	L Wrench	1
10	2200-2510	Screw Holding Forcep SW8	1
11	2200-2511	Screw Holding Forcep SW9.5	1
12	2200-2512	Drill Bit 3.5*210	1
13	2200-2513	Drill Bit 3.5*210 With Blcok	1
14	2200-2514	Drill Bit 4.0*210	1
15	2200-2515	Drill Bit 4.0*210 With Block	1
16	2200-2516	Location Device	1
17	2200-2517	Probe Straight	1
18	2200-2518	Probe Bent	1
19	2200-2519	Drill Sleeve	1
20	2200-2520	Depth Gague 0-90mm	1
21	2200-2521	Screwdriver Hex SW3.5 Length 270mm	1
22	2200-2522	Screwdriver Hex SW3.5 Length 270mm	1
23	2200-2523	AWL 4.0*300mm	1
24	2200-2524	Wrench SW8	1
25	2200-2525	Wrench SW9.5	1
26	2200-2526	Universal Screwdriver SW3.5*280mm	1
27	2200-2527	Bracescrewdriver	1
28	2200-2528	AWL 3.5*300mm	1
29	2200-2529	Universal Wrench SW8	1
30	2200-2530	Universal Wrench SW9.5	1
31	2200-2531	Insertor Forcep	1
32	2200-2532	Tap 5.0	1
33	2200-2533	Limited Drill Bit 4x20-65mm	1
34	2200-2534	Tap 6.0	1
35	2200-2535	Distractor Forcep	1
36	2200-2536	Distractor Device	1
37	2200-2537	Measurer	1
38	2200-2538	Distractor Forcep With Hook	1
39	2200-2540-N	Aluminium Box	1

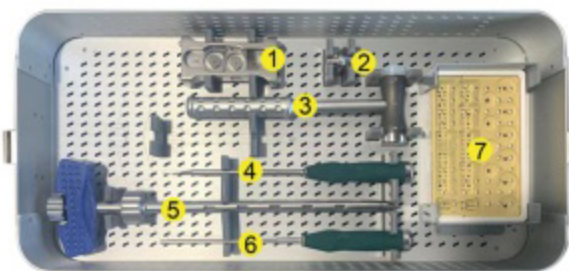
Stryker Expandable Cage Instrument Set 2200-20

NO	REF	Description	Qty
1	2200-2001	Packing Block	1
2	2200-2002	Pusher for End Cap	1
3	2200-2003	Hammer	1
4	2200-2004	Flat Driver for Locking	1
5	2200-2005	Holder & Insertor	1
6	2200-2006	Impactor	1
7	2200-2007	Cage Box	1
8	2200-2008	Aluminium Box	1

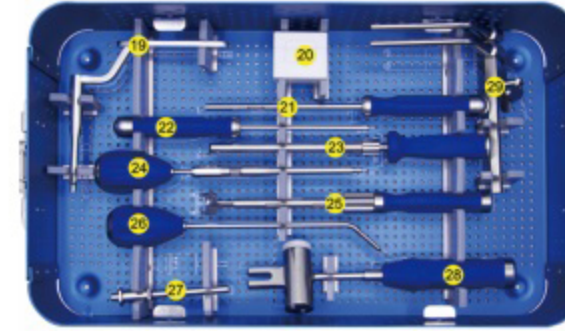
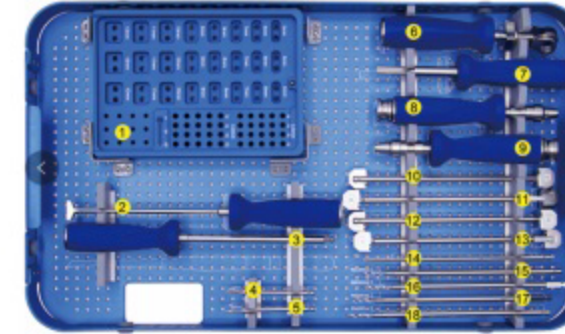
Cervical Peek Cage With 2 Locking Screw Instrument Set 2200-21

NO	REF	Description	Qty
1	2200-2101	Implant Box	1
2	2200-2102	Flat Type Pusher	1
3	2200-2103	Ball Type Pusher	1
4	2200-2104	Brace Screw	1
5	2200-2104	Brace Screw	1
6	2200-2106	Screwdriver Stander	1
7	2200-2107	Bone Graft Insertor	1
8	2200-2108	Quick Coupling Handle AO	1
9	2200-2108	Quick Coupling Handle AO	1
10	2200-2110	Trail 5mm	1
	2200-2111	Trail 6mm	1
11	2200-2112	Trail 7mm	1
	2200-2113	Trail 8mm	1
12	2200-2114	Trail 9mm	1
	2200-2115	Trail 10mm	1
13	2200-2116	Trail 11mm	1
	2200-2117	Trail 12mm	1
14	2200-2118	Star Screwdriver Quick Coupling AO	1
15	2200-2119	Drill Bit 12mm	1
16	2200-2120	Drill Bit 14mm	1
17	2200-2121	Drill Bit 16mm	1
18	2200-2122	Drill Bit 18mm	1
19	2200-2123	Drill Guider	1
20	2200-2124	Bone Graft Cage	1
21	2200-2125	Brace Screwdriver	1
22	2200-2126	AWL	1
23	2200-2127	Angle Screwdriver	1
24	2200-2128	AWL with Sleeve	1
25	2200-2129	Cage Holder	1
26	2200-2130	Angled AWL	1
27	2200-2131	Screwdriver Sleeve	1
28	2200-2132	Hammer	1
29	2200-2133	Retractor	1
30	2200-2134-N	Aluminium Box	1

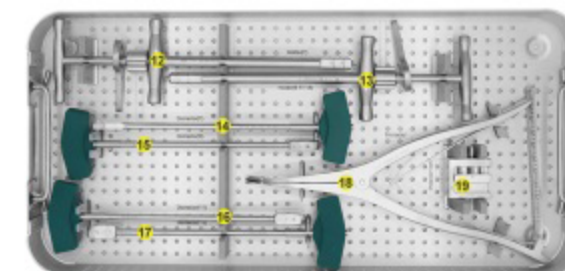
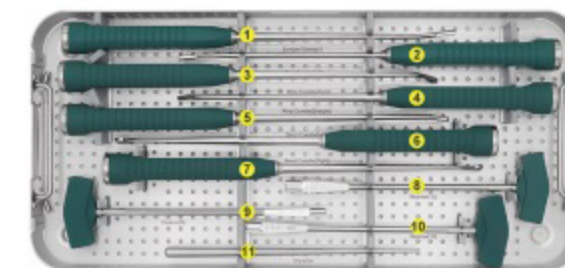
Expandable Posterior Lumbar Titanium Cage Instrument Set 2200-24

NO	REF	Description	Qty
1	2200-2401	Ring Curette Left	1
2	2200-2402	Ring Curette Straight	1
3	2200-2403	Ring Curette Right	1
4	2200-2404	Bent Curette Left	1
5	2200-2405	Bent Curette Right	1
6	2200-2406	Scraper Straight	1
7	2200-2407	Scraper Bent	1
8	2200-2408	Reamer 8mm	1
9	2200-2409	Reamer 10mm	1
10	2200-2410	Reamer 12mm	1
11	2200-2411	Impactor	1
12	2200-2412	Cage Holder	1
13	2200-2413	Cage Holder	1
14	2200-2414	Cage Template 7mm	1
15	2200-2415	Cage Template 9mm	1
16	2200-2416	Cage Template 11mm	1
17	2200-2417	Cage Template 13mm	1
18	2200-2418	Distractor	1
19	2200-2419	Bone Grafe Box	1
20	2200-2420	Aluminium Box	1

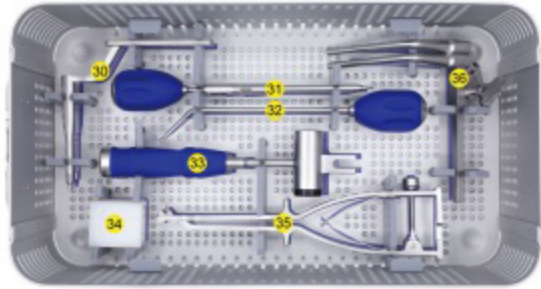
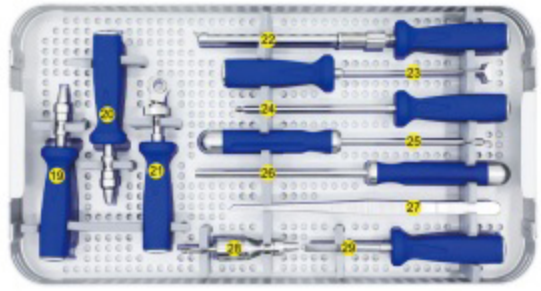
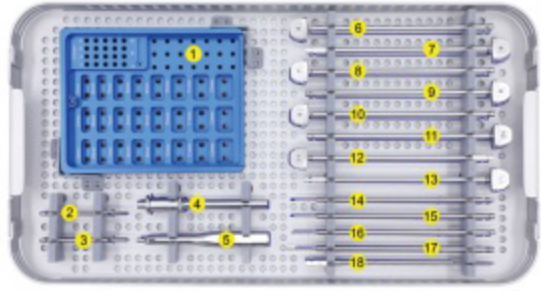
Cervical Peek Cage With 4 Locking Screw Instrument Set 2200-22

NO	REF	Description	Qty
1	2200-2201	Implant Box	1
2	2200-2202	Brace Screw	1
3	2200-2203	Brace Screw	1
4	2200-2204	Screwdriver Sleeve	1
5	2200-2205	Sleeve	1
6	2200-2206	Trail 5mm	1
7	2200-2207	Trail 6mm	1
8	2200-2208	Trail 7mm	1
9	2200-2209	Trail 8mm	1
10	2200-2210	Trail 9mm	1
11	2200-2211	Trail 10mm	1
12	2200-2212	Trail 11mm	1
13	2200-2213	Trail 12mm	1
14	2200-2214	Drill Bit 12mm	1
15	2200-2215	Drill Bit 14mm	1
16	2200-2216	Drill Bit 16mm	1
17	2200-2217	Drill Bit 18mm	1
18	2200-2218	Star Screwdriver Quick Coupling AO	1
19	2200-2219	Quick Coupling Handle AO	1
20	2200-2220	Quick Coupling Handle AO	1
21	2200-2221	Screwdriver Stander	1
22	2200-2222	Angle Screwdriver	1
23	2200-2223	Flat Type Pusher	1
24	2200-2224	Ball Type Pusher	1
25	2200-2225	AWL	1
26	2200-2226	Brace Screwdriver	1
27	2200-2227	Cage Holder	1
28	2200-2228	Torque Wrench 1.2N.m	1
29	2200-2229	Bone Graft Inserter	1
30	2200-2230	Drill Guider	1
31	2200-2231	AWL with Sleeve	1
32	2200-2232	Angled AWL	1
33	2200-2233	Hammer	1
34	2200-2237	Bone Graft Cage	1
35	2200-2238	Cage Holder Forcep	1
36	2200-2236	Retractor	1
37	2200-2234-N	Aluminium Box	1

Peek Cervical Cage-II Instrument Set 2200-14

NO	REF	Description	Qty
1	2200-1401	Trail 4mm	1
2	2200-1402	Trail 5mm	1
3	2200-1403	Trail 6mm	1
4	2200-1404	Trail 7mm	1
5	2200-1405	Trail 8mm	1
6	2200-1406	Trail 9mm	1
7	2200-1407	Trail 10mm	1
8	2200-1408	Bone Graft Cage	1
9	2200-1409	Bone Graft Inserter	1
10	2200-1410	Curved Reglator	1
11	2200-1411	Peek Cage Holder (Long)	1
12	2200-1412	Peek Cage Holder (Short)	1
13	2200-1413	Aluminium Box	1

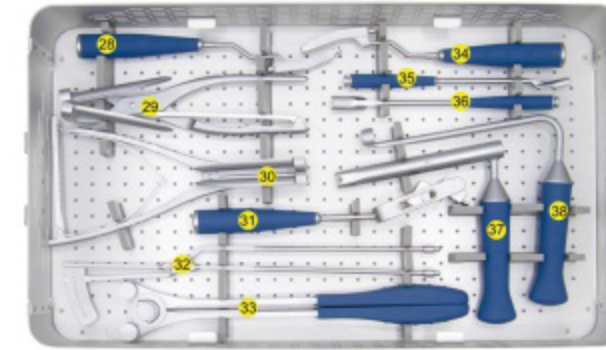
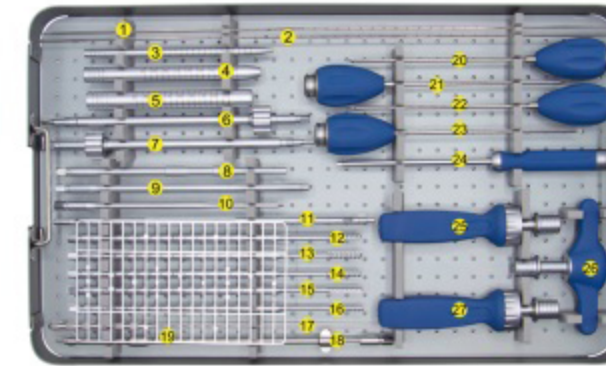
Minimally Invasive Pedicle Screw Instrument Set 2200-17

NO	REF	Description	Qty
1	2200-1701	Conical Guide Pin Ø1.5*500	3
2	2200-1702	Blunt Guide Pin Ø1.5*500	3
3	2200-1703	Drill Sleeve Ø7.2*1.7*164	1
4	2200-1704	Drill Sleeve Ø13*7.3*153	1
5	2200-1705	Drill Sleeve Ø15.6*13.1*143	1
6	2200-1706	Cannulated Polyaxial Screwdriver	1
7	2200-1706	Cannulated Polyaxial Screwdriver	1
8	2200-1708	Rod Pusher Ø6	1
9	2200-1709	Stardriver T5.05	2
10	2200-1710	Hex Screwdriver SW2.5	1
11	2200-1711	Nut Holding Forcep SW4.5	2
12	2200-1712	Tap Ø7.0	1
13	2200-1713	Tap Ø6.5	1
14	2200-1714	Tap Ø6.0	1
15	2200-1715	Tap Ø5.5	1
16	2200-1716	Tap Ø5.0	1
17	2200-1717	Curved Feeler	1
18	2200-1718	Bone Cement Pusher	1
19	2200-1719	Location Plate	1
20	2200-1720	AWL Ø3.3*233	1
21	2200-1720	AWL Ø3.3*233	1
22	2200-1720	AWL Ø3.3*233	1
23	2200-1720	AWL Ø3.3*233	1
24	2200-1724	Screwdriver SW3.5	1
25	2200-1725	Straight Rechat Handle	1
26	2200-1726	T-handle Quick Coupling	1
27	2200-1725	Straight Rechat Handle	1
28	2200-1728	Rod Holding Forcep	1
29	2200-1729	Compression Forcep	1
30	2200-1730	Distractor Forcep	1
31	2200-1731	Reduction Forcep	1
32	2200-1732	Rod Measurement	1
33	2200-1733	Rod Bender	1
34	2200-1728	Rod Holding Forcep	1
35	2200-1735	Break-off Forcep	1
36	2200-1735	Break-off Forcep	1
37	2200-1737	Anti-rotation Sleeve	1
38	2200-1738	Counter Torque for Screw Cutter	1
39	2200-1739	Aluminium Box	1

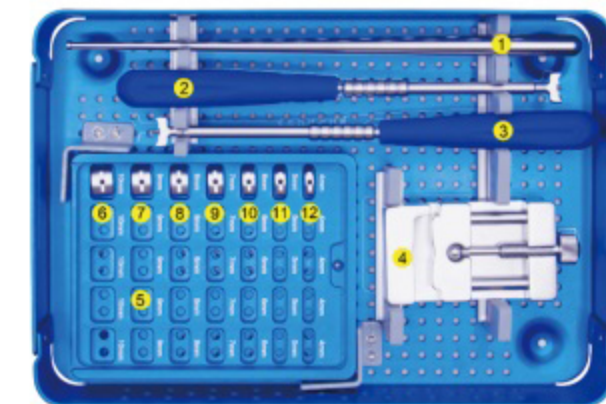
Peek Cervical Cage-I Instrument Set 2200-06

NO	REF	Description	Qty
1	2200-0601	Bone Graft Inserter	1
2	2200-0602	Trail Holder	1
3	2200-0603	Peek Cage Holder	1
4	2200-0604	Bone Graft Cage	1
5	2200-0605	Cage Box	1
6	2200-0606	Trail 10mm	1
7	2200-0607	Trail 9mm	1
8	2200-0608	Trail 8mm	1
9	2200-0609	Trail 7mm	1
10	2200-0610	Trail 6mm	1
11	2200-0611	Trail 5mm	1
12	2200-0612	Trail 4mm	1
13	2200-0613-N	Aluminium Box	1

OLIF Cage Instrument Set 315

NO	REF	Description	Qty
1	315270	Distractor 7mm	1
2	315-330	Cage Trail (6°) 55*18*8mm	1
3	315-331	Cage Trail (6°) 55*18*10mm	1
4	315-332	Cage Trail (6°) 55*18*12mm	1
5	315-333	Cage Trail (6°) 55*18*14mm	1
6	315-340	Cage Trail (9°) 55*18*9mm	1
7	315-341	Cage Trail (9°) 55*18*11mm	1
8	315-342	Cage Trail (9°) 55*18*13mm	1
9	315-343	Cage Trail (9°) 55*18*15mm	1
10	315-032	Cage Holder	1
11	315-052	Impactor Box	1
12	315-060	Impactor Long	1
13	315-061	Impactor Short	1
14	315-071	Handle	1
15	315-082	Pusher	1
16	315-094	Stripper Large	1
17	315-101	Stripper Small	1
18	315-131	Bone File Arc	1
19	315-132	Bone File Wedge	1
20	315-140	Scraper	1
21	315-171	Curette 5°	1
22	315-180	Ring Curette	1
23	315-120	Square Reamer 7mm	1
24	315-121	Square Reamer 8mm	1
25	315-122	Square Reamer 9mm	1
26	315-123	Square Reamer 10mm	1
27	315-124	Square Reamer 11mm	1
28	315-125	Square Reamer 12mm	1
29	315-126	Square Reamer 13mm	1
30	315-240	knife Holder	1
31	315-211	Rongeur 3mm	1
32	315-191	Nucleus pulposus forceps straight 3mm	1
33	315-311	Nucleus pulposus forceps straight 5mm	1
34	315-202	Nucleus pulposus forceps 45°*3mm	1
35	315-000	Aluminium Box	1

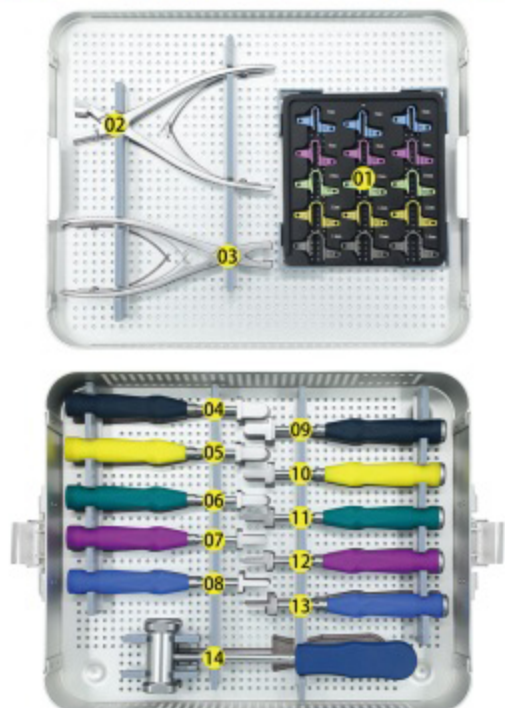
Coflex Interlaminar Device Instrument Set 2200-29

NO	REF	Description	Qty
1	2200-2914	Coflex Interlaminar Device Container	1
2	2200-2901	Distractor Forcep	1
3	2200-2902	Compression Forcep	1
4	2200-2912	Trial 14mm	1
5	2200-2911	Trial 12mm	1
6	2200-2910	Trial 10mm	1
7	2200-2909	Trial 8mm	1
8	2200-29.08	Trial 6mm	1
9	2200-2907	Insenter 14mm	1
10	2200-2906	Insenter 12mm	1
11	2200-2905	Insenter 10mm	1
12	2200-2904	Insenter 8mm	1
13	2200-2903	Insenter 6mm	1
14	2200-2913	Hammer	1
15	2200-2915-N	Aluminium Box	1

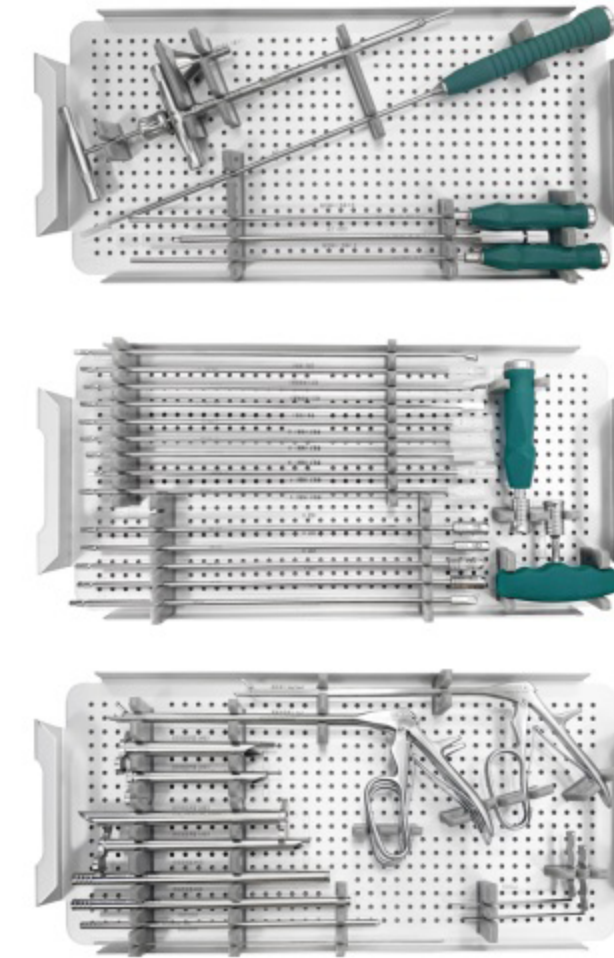
LIFUS Titanium Cage/RAFUS PEEK Cage Instrument Set 318-005

NO	REF	Description	Qty
1	318-124	Cage Insertor	1
2	318-133	Bone Graft Funnel	1
3	318-380	Cage Trial 8mm	1
4	318-381	Cage Trial 9mm	1
5	318-382	Cage Trial 10mm	1
6	318-383	Cage Trial 11mm	1
7	318-384	Cage Trial 12mm	1
8	318-430	Guide Pin 1.5*300	1
9	318-010	Location Pin 6.3*260	1
10	318-272	Inner & Outer Dilator 10*240	1
11	318-273	Inner & Outer Dilator 10*220	1
12	318-032	Operating Working Channel I 10mm	1
13	318-034	Operating Working Channel I 12mm	1
14	318-042	Operating Working Channel II 10mm	1
15	318-044	Operating Working Channel II 12mm	1
16	318-050	Retractor I 110	1
17	318-290	Reamer 8mm	1
18	318-291	Reamer 9mm	1
19	318-292	Reamer 10mm	1
20	318-293	Reamer 11mm	1
21	318-294	Reamer 12mm	1
22	318-300	Bone File	1
23	318-310	Bone Cutter	1
24	318-320	Scraper(Ring)	1
25	318-330	Scraper(Square)	1
26	318-340	Curette	1
27	318-061	Nucleus Pulposus Forcep 260*3.0 Straight	1
28	318-063	Nucleus Pulposus Forcep 260*5.0 Straight	1
29	318-070	Rongeurs 260*3.0	1
30	318-350	T-handle	1
31	318-360	Straight Handle	1
32	318-370	Distractor 6*8mm	1
33	318-146	Impactor for Funnel Long	1
34	318-147	Impactor for Funnel Short	1
35	318-150	Holder for cage end cap SW3.5	1
36	318-000	Aluminium Box	1

Spinal Pedicle Screw Box 1000-0109



Size:28*13*10cm
Mono Screw, Mono Reduction Screw, Poly Screw, Poly Reduction Screw, Crosslink, Rod

Minimally Invasive Spine Screw Box



Posterior Cervical Screw Box 1000-0110





Size:28*13*10cm
Mono Screw, Mono Reduction Screw, Poly Screw, Poly Reduction Screw, Crosslink, Rod

Φ3.7 Thoracic Layer by Layer Puncture(PVP) QN-001



Picture	Accessories	REF	Qty
	Guide Needle Φ1.0	C/YZ-I-Φ1.0	2
	Vertebral Perforator Φ2.5	C/ZC-II- Φ2.5	2
	Hand Drill Φ3.0	C/SZ-I- Φ3.0	1
	Dilated Casing Φ3.0/3.7	C/KQ-I- Φ3.0 C/KG-I- Φ3.7	2
	Cement Delivery Tube Procedure Flat Φ3.0	T/I Flat- Φ3.0	6

Φ3.7 Thoracic Layer by Layer Puncture(PKP) QN-002

Picture	Accessories	REF	Qty
	Guide Needle Φ1.0	C/YZ-I-Φ1.0	2
	Vertebral Perforator Φ2.5	C/ZC-II- Φ2.5	2
	Hand Drill Φ3.0	C/SZ-I- Φ3.0	1
	Dilated Casing Φ3.0/3.7	C/KQ-I- Φ3.0 C/KG-I- Φ3.7	2
	Cement Delivery Tube Procedure Flat Φ3.0	T/I Flat- Φ3.0	6

	Kyphoplasty Ballon Φ10	BL-Z3/10	1
	Balloon Filling Device	BL-CY-20	1

Φ3.7 Thoracic One Puncture(PVP) QN-003

Picture	Accessories	REF	Qty
	Vertebral Perforator (3 blades tip) Φ3.7	C/CZ-IV Φ3.7	2
	Hand Drill Φ3.0	C/SZ-I- Φ3.0	1
	Cement Delivery Tube Procedure Flat Φ3.0	T/I Flat- Φ3.0	4

Φ3.7 Thoracic One Puncture(PKP) QN-004

Picture	Accessories	REF	Qty
	Vertebral Perforator (3 blades tip) Φ3.7	C/CZ-IV Φ3.7	2
	Hand Drill Φ3.0	C/SZ-I- Φ3.0	1
	Cement Delivery Tube Procedure Flat Φ3.0	T/I Flat- Φ3.0	4
	Kyphoplasty Ballon Φ10	BL-Z3/10	1
	Balloon Filling Device	BL-CY-20	1

Φ4.2 Lumbar Layer by Layer Puncture(PVP) QN-005



Picture	Accessories	REF	Qty
	Guide Needle Φ1.5	C/YZ-I-Φ1.5	2
	Vertebral Perforator Φ3.0	C/ZC-II- Φ3.0	2
	Hand Drill Φ3.5	C/SZ-I- Φ3.5	1
	Dilated Casing Φ3.5/4.2	C/KQ-I- Φ3.0 C/KG-I- Φ4.2	2
	Cement Delivery Tube Procedure Flat Φ3.5	T/I Flat- Φ3.5	6

Φ4.2 Lumbar Layer by Layer Puncture(PKP) QN-006

Picture	Accessories	REF	Qty
	Guide Needle Φ1.5	C/YZ-I-Φ1.5	2
	Vertebral Perforator Φ3.0	C/ZC-II- Φ3.0	2
	Hand Drill Φ3.5	C/SZ-I- Φ3.5	1
	Dilated Casing Φ3.5/4.2	C/KQ-I- Φ3.5 C/KG-I- Φ4.2	2
	Cement Delivery Tube Procedure Flat Φ3.5	T/I Flat- Φ3.5	6

	Kyphoplasty Ballon Φ15	BL-Z3/15	1
	Balloon Filling Device	BL-CY-20	1

Φ4.2 Lumbar One Puncture(PVP) QN-007

Picture	Accessories	REF	Qty
	Vertebral Perforator (3 blades tip) Φ4.2	C/CZ-IV Φ4.2	2
	Hand Drill Φ3.5	C/SZ-I- Φ3.5	1
	Cement Delivery Tube Procedure Flat Φ3.5	T/I Flat- Φ3.5	4

Φ4.2 Lumbar One Puncture(PKP) QN-008

Picture	Accessories	REF	Qty
	Vertebral Perforator (3 blades tip) Φ4.2	C/CZ-IV Φ4.2	2
	Hand Drill Φ3.5	C/SZ-I- Φ3.5	1
	Cement Delivery Tube Procedure Flat Φ3.5	T/I Flat- Φ3.5	4
	Kyphoplasty Ballon Φ15	BL-Z3/15	1
	Balloon Filling Device	BL-CY-20	1

Kyphoplasty Ballon

Picture	Accessories	REF
	Φ20	BL-Z3/20

Bone Cement Injection

Picture	REF
	BL-100

Spine Bone Cement Germany

Picture	REF
	Osteopal Plus-001

Spine Bone Cement China

Picture	REF
	SV300